

doi:10.15199/48.2015.04.02

# Compensation of magnetic disturbances caused by sensors in a differential magnetometric system

**Abstract.** Study of low magnetic fields necessitates the use of precision magnetometers working in a differential system. Minimization of this error is a substantial issue in the case of magnetometers working in a differential system on a mobile platform. The compensation method of heading error consists in taking measurements of changes in magnetic induction with the use of the tested magnetometer for various locations of the sensor in relation to the vector of the Earth's magnetic flux density.

**Streszczenie.** Badania bardzo słabych pól magnetycznych wymagają zastosowania precyzyjnych magnetometrów pracujących w układzie różnicowym. W pracy opisano dwie metody kompensacji tego błędu. Metoda kompensacji błędu kierunkowego polega na wykonywaniu pomiarów zmian indukcji magnetycznej przy zastosowaniu badanego magnetometru dla różnych położeń czujnika w stosunku do wektora indukcji magnetycznej Ziemi. Znając zależność tego błędu w funkcji położenia czujnika można wpływ błędu kierunkowego skutecznie zminimalizować. (Kompensacja zaburzeń magnetycznych wywołanych przez czujniki różnicowego systemu pomiarowego)

**Keywords:** magnetometer, magnetic field, heading error.

**Słowa kluczowe:** magnetometr, pole magnetyczne, błąd kierunkowy.

## Introduction

There are many differential magnetic systems operating on mobile platforms such as planes, helicopters or UAVs [3]–[6]. These systems use mainly optically-pumped magnetometers [10], [11]. Measurement of differences in the modulus of magnetic flux density with the use of these systems has practical applications in geological and military research. In the case of detecting of underwater objects of low magnetic signature using a differential system is subject to some limitations in application. The limitations result from low values of disturbances in the magnetic field in the surroundings of the detected object. The difference in the modulus of magnetic flux density measured with the use of magnetometers installed on one platform is very small in this case – at the level of the noise level or below it. A larger difference between the signals can be achieved by locating the magnetic sensors at a considerably larger distance from one sensor to another. Optically-pumped magnetometers based on CS-133 are encumbered with the so-called heading error. This error depends on the location of the sensor in relation to the vector of the Earth's magnetic field. If the sensor is located at a distance far enough from the electronic systems of the magnetometer, then the results of measurement of the magnetic field is encumbered with an error that results mainly from the heading error. This paper describes a concept of a differential magnetic system in which magnetometers are installed on two different platforms and experimental results of the heading error compensation of a differential magnetometric system. The values of magnetic flux density of the pT order of magnitude are measured in this system, therefore, the heading error compensation is necessary. This paper presents two compensating methods for the heading error.

## Analysis of magnetic field of a submarine

Ferromagnetic objects located under the water surface such as shipwrecks or submarine vessels disturb the uniformity of the Earth's magnetic flux density. In the case of submarines this disturbance is particularly small due the degaussing process used at warships [8], [9]. The analysis of disturbances in the distribution of the magnetic field of submarines was performed with the use of the simulation program Opera 3D. The model of a submarine is shown in Fig. 1.

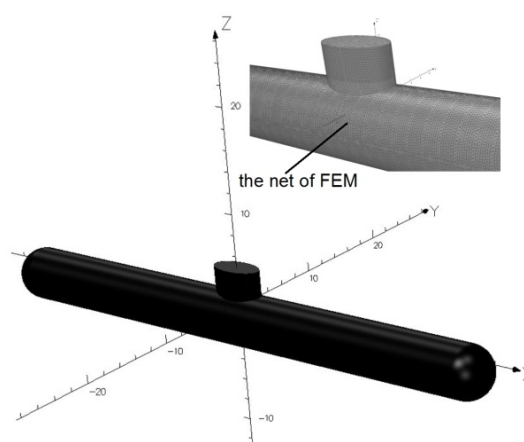

Fig. 1. The model of a submarine.

The disturbance in the Earth's magnetic flux density is small, it amounts to several nT at the height equal to the double length of the submarine (Fig. 2). The dimensions of the spatial distribution of disturbance in the magnetic field for larger distances between the magnetometric system and the submarine are considerable, they reach the value of several hundred metres. It is possible to enlarge the object detection area by using the differential method and increasing the distance between the two magnetic sensors so that it is considerably larger than in the case of airplanes.

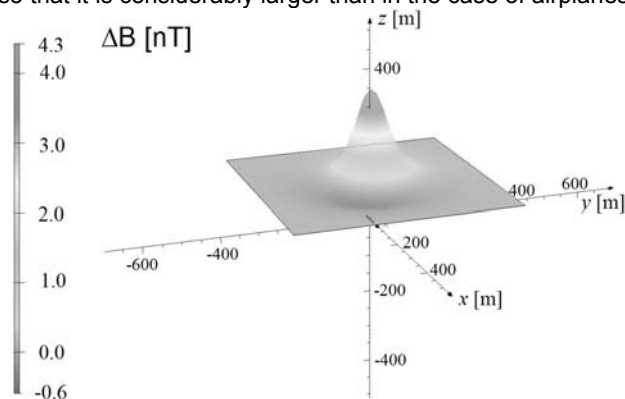

Fig. 2 Disturbance in the magnetic flux density caused by a submarine with a magnetometric system located at the height equal to the double length of the submarine (course of the ship 45°, the length of the ship 50 m)

### Concept of a differential magnetometric system

Figure 3 shows a concept of a differential magnetometric system. The sensors of the magnetometers are placed in the gondolas pulled by two platforms (Fig. 3). The transmission of the measurement data between the platforms is made via a wireless communication system. When such solution is applied, the difference in the modulus of magnetic flux density can be measured at any distance  $\Delta y_s$  between the sensors. The performed analysis of the vessel's magnetic field showed that in the case of submarine objects detection (shipwrecks, submarines) of the length ranging from 50 m to 100 m, the optimum distance between the sensors is  $\Delta y_s \in (100 \text{ m}, 150 \text{ m})$ .

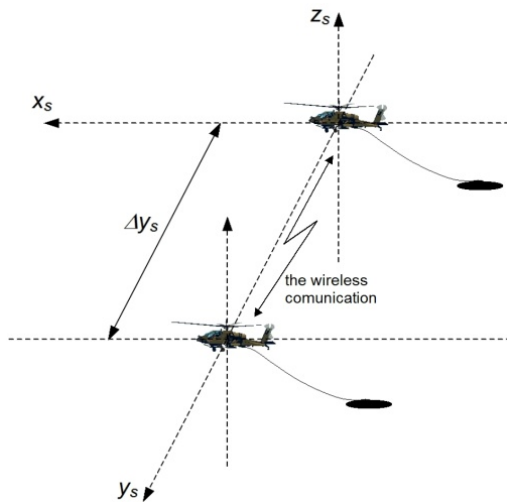

Fig.3 The concept of a differential magnetometric system

### Compensation of the heading error

Optically pumped magnetometers are encumbered with the so-called heading error. This error depends on the angle between the direction of the sensor axis and the direction of the vector of the magnetic flux density. Magnetometers based on Cs-133 are typically encumbered with a heading error  $\pm 150 \text{ pT}$ . Changes of location of the magnetic sensor in space while taking measurements generate the interfering signal related to the heading error. The dependence between the heading error in relation to  $\mathbf{B}_E$  (Fig. 4) can have different values for each magnetometer. The sensor should be located as far away as possible from the dead zone (Fig. 4), in which it is not possible to take measurements. The tests of the optically pumped magnetometers were carried out in an undeveloped area free of magnetic disturbances. The sensors were installed on two amagnetic measurement platforms. One of the sensors was immovable while taking measurements, whereas the other one was turning around in a rotary device (Fig. 5). Operation of the magnetometers of the frequency 10 Hz was synchronised with the use of a GPS module. In order to define the spatial location of the sensor a vector magnetometer was used.

After calibration had been performed in order to verify the efficacy of the heading error compensation, a series of measurement tests was carried out. The area where tests are carried out should be characterized by a highly uniform magnetic field. As the measurements are taken relatively close to the ground, it is not easy to find an area with a highly uniform magnetic field. Disturbances typical for northern Poland amount to about 100 pT/m. It is for this reason that the sensor of the scalar magnetometer was placed close to the rotating device after an area with disturbances in the uniformity of the magnetic field of 20 pT/m had been selected (Fig. 5).

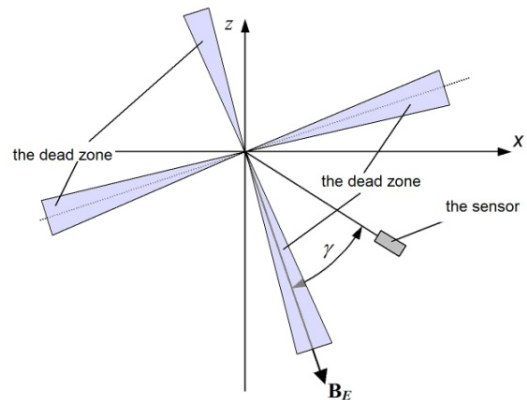

Fig. 4. The dead zone of an optically pumped magnetometer

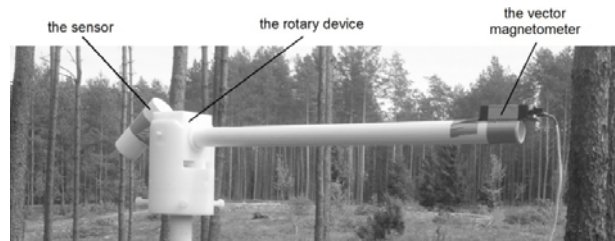

Fig. 5. Measurement workstation for tests of efficacy of the heading error compensation

### 1<sup>st</sup> method of the heading error compensation

The dependence between the heading error and the sensor location in relation to the vector of the Earth's magnetic flux density is constant. It is possible to compensate the heading error if the values of the heading error for various locations of the sensor and its actual location are known. If there are no metal elements in the vicinity of the sensor in which eddy currents could be induced, then, basing on the results of stationary measurements, it is possible to define the dependence of the heading error in the function of the pitch, roll and yaw angles. A digital compass, e.g. HMR3400, can be used to measure the tilt of the sensor and the horizontal direction. After the dependence between the heading error has been measured for the chosen tilts of the sensor, it is possible to compensate the heading error by applying a 3D interpolation method [7]. For the purpose of this study it was assumed that the pitch and roll angles tilts are  $\pm 5^\circ$ . Measurements of disturbances in the magnetic flux density were taken for the horizontal location at every  $30^\circ$ . Thus, 108 data points were obtained. Figure 6 shows a Cartesian coordinate system with the rotation angles pitch ( $\psi$ ), roll ( $\beta$ ) and yaw ( $\alpha$ ). Examples of disturbances in the magnetic field density for four chosen tilts of the sensor are shown in Fig. 7.

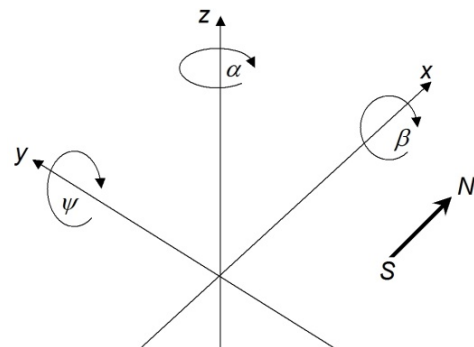

Fig. 6. Rotation angles of the sensor

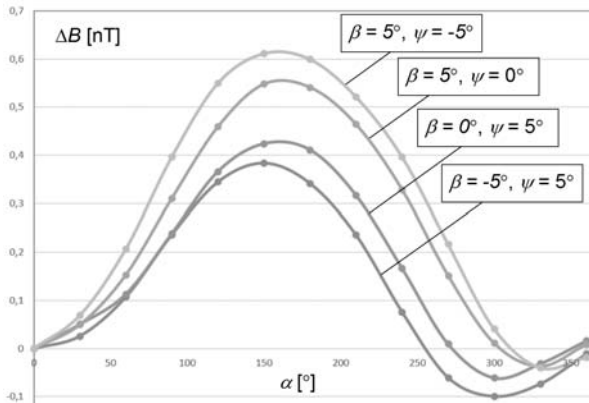

Fig. 7. Disturbances in the magnetic flux density for four selected angles of the sensor

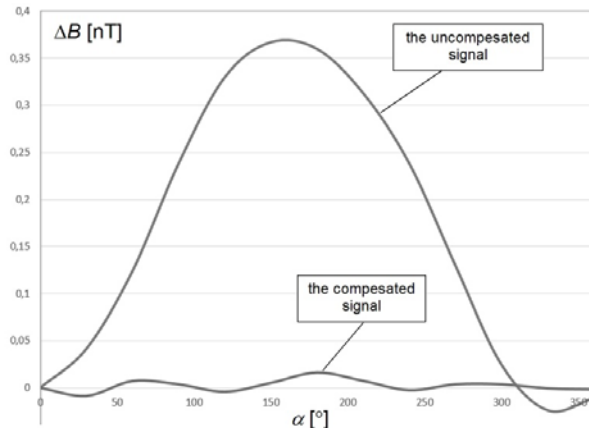

Fig. 8. The uncompensated and compensated signal for a full rotation of the sensor in a horizontal plane

Figure 8 shows disturbances in the magnetic flux density related to the heading error occurring during the sensor rotation in an approximately horizontal plane and the result of compensation ( $\beta \approx 0^\circ$ ,  $\psi = 0^\circ$ ). The error related to the heading error was reduced to about 20 pT.

## 2<sup>ST</sup> method of the heading error compensation

A classic compensation method for magnetic disturbances generated by platforms [1] is another method for the heading error compensation that can be applied. This method is related mainly to the compensation of magnetic disturbances generated by airplanes [1]–[3]. It should be applied particularly in the situations when other electronic systems are installed in the gondola along with the sensor. The interference sources can be divided into three groups: permanent, induced and eddy currents magnetic fields. The first kind of source is independent of a gondola orientation relative to the Earth's magnetic flux density. It is the permanent magnetism of all ferromagnetic parts of a gondola. The second kind of source - the induced magnetic field - depends on the position of ferromagnetic parts in relation to the Earth's magnetic flux density. Eddy currents, which are induced in any electricity conducting parts of the gondola, are the third source of interference. If there are no closed metal objects in the gondola, then the third source of interference can be eliminated from the model of magnetic interference. The Earth's magnetic field disturbed by permanent magnetization of a gondola is described by the following formula [1]:

$$(1) \quad H_{dp} = k_1 \cos X + k_2 \cos Y + k_3 \cos Z$$

and the induced magnetization is described by the following formula [1]:

$$(2) \quad H_{di} = H_E \begin{bmatrix} k_4 & k_5 & k_6 & k_7 & k_8 & k_9 \end{bmatrix} \begin{bmatrix} (\cos X)^2 \\ \cos X \cos Y \\ \cos X \cos Z \\ (\cos Y)^2 \\ \cos Y \cos Z \\ (\cos Z)^2 \end{bmatrix}$$

where:  $\cos X = H_{xE}/H_E$ ,  $\cos Y = H_{yE}/H_E$ ,  $\cos Z = H_{zE}/H_E$  – the direction cosines,  $H_E$  – modulus of the Earth's magnetic field intensity,  $H_{xE}$ ,  $H_{yE}$ ,  $H_{zE}$ , components of the Earth's magnetic intensity vector,  $k_i$  – compensation coefficients.

The resulting interference in the magnetic field intensity is described by the following formula:

$$(3) \quad H_d = H_{dp} + H_{di}$$

The compensation coefficients were defined on the basis of the measurement results for disturbances in the magnetic flux density during the changes of the sensor location in four magnetic directions (NS, SN, WE, EW). The compensation coefficients were calculated by minimizing the norm:

$$(4) \quad Q = \sum_{n=1}^N \left( H_{d,n} - \sum_{i=1}^9 k_i A_{i,n} \right)^2$$

where:  $H_{d,n}$  – disturbed intensity of the magnetic field in time  $t_n$ ,  $k_i$  – compensation coefficients,  $A_{i,n}$  – functions of direction cosines and derivatives of direction cosines in time  $t_n$ .

The method of least squares was applied to minimize the norm (4). The tilts like pitch, roll and yaw were performed. The direction cosines can be measured with the use of a vector magnetometer, e.g. HMR2300. Figure 9 shows the changes of the direction cosines during the changes in the sensor location. Figure 10 presents uncompensated and compensated signals. The improvement ratio of magnetic compensation equals  $IR = 20.8$  (5).

$$(5) \quad IR = \frac{\sigma_{nc}}{\sigma_c}$$

where:  $\sigma_{nc}$  – standard deviation of uncompensated signal,  $\sigma_c$  – standard deviation of compensated signal.

The error related to the heading error was reduced to about 25 pT in this case.

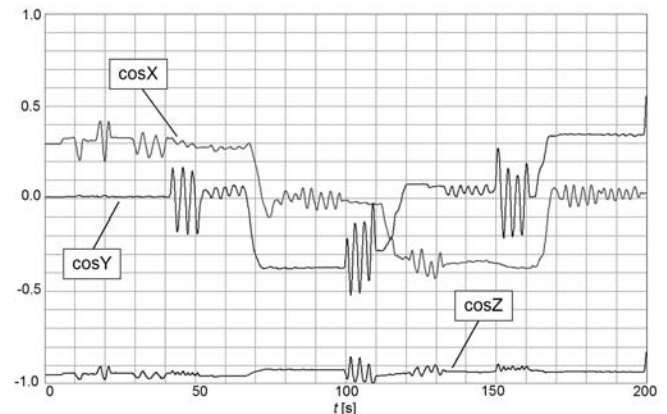

Fig. 9. Changes of the direction cosines during the sensor tilts

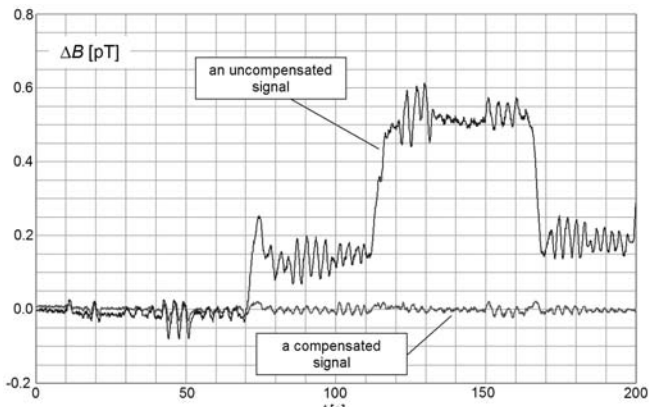

Fig. 10. Changes of uncompensated and compensated signals

## CONCLUSIONS

The two described compensation methods for heading error give similar results. The method consisting in taking measurements of the heading error for the chosen angles of pitch, roll and yaw gives good results. This procedure requires taking numerous measurements and using an algorithm of a 3D interpolation. A smoother compensated signal in comparison to the signal obtained by the other method is one of the advantages of this method. The classic compensation method that uses Leliak's model [1] is a simpler method both in terms of taking measurements necessary to calculate compensation coefficients as well as compensation algorithm. In a differential magnetometric system the heading error compensation is performed for each magnetometer. Subsequently the difference in the modulus of the magnetic flux density is calculated. Disturbances in the measurement signal, which result from the imperfect heading error compensation of magnetometers can amount to 50 pT in the tested system.

## ACKNOWLEDGMENT

This work was supported in part by the National Centre for Research and Development Grant DOBR/0062/R/ID1/2012/03.

## REFERENCES

- [1] Leliak P.: Identification and Evaluation of Magnetic Field Sources of Magnetic Airborne Detector Equipped Aircraft. *IRE Trans. Aerospace and Navigational Electronics*, vol. 8, September 1961, pp. 95-105.
- [2] Hardwick C.D.: Important design considerations for inboard airborne magnetic gradiometers. *Geophysics*, vol. 49, no. 11, November 1984, pp.2004-2018.
- [3] Hirota M., Furuse T., Ebana K., Kubo K., Tsushima K., Inaba T., Shima A., Fujinuma M., Tojyo N.: Magnetic Detection of a surface ship by an airborne LTS SQUID MAD. *IEEE Transactions on Applied Superconductivity*, vol.11, no.1, March 2001, pp.884-886.
- [4] Allen G., Matthews R., Wynn M.: Mitigation of Platform Generated Magnetic Noise Impressed on a Magnetic Sensor Mounted in an Autonomous Underwater Vehicle. *MTS/IEEE Oceans*, 1999, pp.63-71.

---

**Autorzy:** prof. dr hab. inż. Kazimierz Jakubiuk, Politechnika Gdańska, Wydział Elektrotechniki i Automatyki, ul. Narutowicza 11/12, 80-233 Gdańsk, E-mail: kazimierz.jakubiuk@pg.gda.pl;  
 dr hab. inż. Mirosław Wołoszyn, Politechnika Gdańska, Wydział Elektrotechniki i Automatyki, ul. Narutowicza 11/12, 80-233 Gdańsk, E-mail: mirosław.woloszyn@pg.gda.pl;  
 mgr inż. Marek Chomnicki, Politechnika Gdańska, Wydział Elektrotechniki i Automatyki, ul. Narutowicza 11/12, 80-233 Gdańsk, E-mail: marek.chomnicki@pg.gda.pl;  
 mgr inż. Jacek Łubkowski, Politechnika Gdańska, Wydział Elektrotechniki i Automatyki, ul. Narutowicza 11/12, 80-233 Gdańsk, E-mail: jacek.lubkowski@pg.gda.pl.