

Positive unstable electrical circuits

Abstract: The instability for the positive linear electrical circuits composed of resistors, coils, condensators and voltage (current) sources are addressed. Three different classes of the positive unstable linear electrical circuits are proposed and analyzed. It is shown that positive electrical circuits are unstable for all values of their parameters if the electrical circuit has at least one mesh containing only inductances and source voltages.

Streszczenie. W artykule rozpatrywane są niestabilne dodatnie liniowe obwody elektryczne złożone z rezystorów, cewek, kondensatorów i źródeł napięcia lub prądu. Analizowane są trzy różne klasy dodatnich obwodów elektrycznych, które są niestabilne dla wszystkich wartości swoich parametrów tzn. rezystancji, indukcyjności i pojemności. Wykazano, że dodatnie obwody elektryczne są niestabilne dla wszystkich wartości swoich parametrów jeżeli zawierają one przynajmniej jedno oczko złożone tylko z cewek i źródeł napięcia. (**Dodatnie niestabilne obwody elektryczne**).

Keywords: positivity, electrical linear circuit, instability.

Słowa kluczowe: dodatniość, liniowy obwód elektryczny, niestabilność.

Introduction

A dynamical system is called positive if its trajectory starting from any nonnegative initial state remains forever in the positive orthant for all nonnegative inputs. An overview of state of the art in positive theory is given in the monographs [1, 2]. Variety of models having positive behavior can be found in engineering, economics, social sciences, biology and medicine, etc..

Positivity of linear electrical circuits has been addressed in [3, 4]. The fractional electrical circuits have been investigated in [5, 6]. Asymptotic stability of positive continuous-time linear systems with mutual state-feedbacks has been analyzed in [7] and of electrical circuits with state-feedbacks in [8]. The robust stability of positive discrete-time linear systems of fractional order has been addressed in [9]. Positive linear systems with different fractional order and electrical circuits have been considered in [10] and positive linear systems consisting of n subsystems with different fractional orders in [11].

In this paper the instability of positive linear electrical circuits composed of resistors, coils, condensators and voltage (current) sources will be analyzed. Three different classes of the positive unstable linear electrical circuits will be proposed. Sufficient conditions will be established under which the positive electrical circuits are unstable for all values of their parameters.

The paper is organized as follows. In section 2 the preliminaries and problem formulation are given. The positive unstable linear electrical circuits of R, L, e type are addressed in section 3. The instability of positive linear systems of G, C, i type are analyzed in section 4 and for positive electrical circuits of R, L, C, e type in section 5. Concluding remarks are given in section 6.

The following notation will be used: \mathfrak{R} - the set of real numbers, $\mathfrak{R}^{n \times m}$ - the set of $n \times m$ real matrices, $\mathfrak{R}_+^{n \times m}$ - the set of $n \times m$ matrices with nonnegative entries and $\mathfrak{R}_+^n = \mathfrak{R}_+^{n \times 1}$, M_n - the set of $n \times n$ Metzler matrices (real matrices with nonnegative off-diagonal entries), I_n - the $n \times n$ identity matrix.

Preliminaries and problem formulation

Consider a linear electrical circuits composed of resistors, coils, condensators and voltage (current) sources. Using the Kirchoff's laws we may describe the transient states in the electrical circuits by state equations [2,4,12-17]

$$(1) \quad \begin{aligned} \dot{x}(t) &= Ax(t) + Bu(t) \\ y(t) &= Cx(t) + Du(t) \end{aligned}$$

where $x(t) \in \mathfrak{R}^n$, $u(t) \in \mathfrak{R}^m$, $y(t) \in \mathfrak{R}^p$ are the state, input and output vectors and $A \in \mathfrak{R}^{n \times n}$, $B \in \mathfrak{R}^{n \times m}$, $C \in \mathfrak{R}^{p \times n}$, $D \in \mathfrak{R}^{p \times m}$.

As the state variables $x_1(t), \dots, x_n(t)$ (the components of $x(t)$) the currents in the coils and voltages on the condensators are chosen, the component of the input vector $u(t)$ are source voltages or source currents and the components of the output vectors $y(t)$ are currents and voltages of the electrical circuit.

It is well-known [5, 10-13] that any linear electrical circuit composed of resistors, coils, condensators and voltage (current) sources can be described by the state equations (1).

Definition 1. The electrical circuit described by the equations (1) (shortly electrical circuit (1)) is called (internally) positive if for any $x(0) = x_0 \in \mathfrak{R}_+^n$ and every

$u(t) \in \mathfrak{R}_+^m$, $t \geq 0$ we have $x(t) \in \mathfrak{R}_+^n$ and $y(t) \in \mathfrak{R}_+^p$, $t \geq 0$.

Theorem 1. [2, 3, 5] The electrical circuit (1) is positive if and only if

$$(2) \quad A \in M_n, \quad B \in \mathfrak{R}_+^{n \times m}, \quad C \in \mathfrak{R}_+^{p \times n}, \quad D \in \mathfrak{R}_+^{p \times m}.$$

Definition 2. The positive electrical circuit (1) is called asymptotically stable if

$$(3) \quad \lim_{t \rightarrow \infty} x(t) = 0 \text{ for any } x_0 \in \mathfrak{R}_+^n.$$

The positive electrical circuit will be called unstable if it is not asymptotically stable.

Theorem 2. [2, 7] The positive electrical circuit (1) is asymptotically stable if and only if

$$(4) \quad \operatorname{Re} s_k < 0 \text{ for } k = 1, 2, \dots, n$$

where s_k , $k = 1, 2, \dots, n$ are the eigenvalues (not necessarily distinct) of the Metzler matrix $A = [a_{i,j}]_{i=1, \dots, n, j=1, \dots, n}$

of the polynomial

$$(5) \quad \begin{aligned} \det[I_n s - A] &= s^n + a_{n-1} s^{n-1} + \dots + a_1 s + a_0, \\ a_{n-1} &= \operatorname{trace} A = \sum_{i=1}^n a_{i,i}, \dots, a_0 = \det[-A]. \end{aligned}$$

Lemma 1. The positive electrical circuit (1) is unstable if

$$(6) \quad \det A = 0.$$

Proof. From (5) and $\det A = s_1 s_2 \dots s_n$ it follows that if (6) holds then at least one eigenvalue of the matrix A is zero. By Theorem 2 the positive electrical circuit (1) is unstable. \square

In the following section three classes of electrical circuits will be presented which are positive and unstable for all values of their resistances R_i , $i = 1, \dots, q_R$; inductances L_j , $j = 1, \dots, q_L$ and capacitances C_k , $k = 1, \dots, q_C$ (shortly for their parameters).

Positive unstable R, L, e electrical circuits

In this section a class of R, L, e electrical circuits composed of resistors with resistances R_i , $i = 1, \dots, q_R$; coils with inductances L_j , $j = 1, \dots, q_L$ and source voltages e_k , $k = 1, \dots, m_e$ which are positive and unstable for all values of R_i, L_j will be proposed.

Example 1. Consider the electrical circuit shown on Figure 1 with given resistances, R_1, R_2 , inductances L_1, L_2 and source voltages e_1, e_2 .

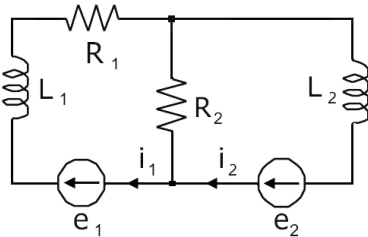

Fig. 1. Electrical circuit

Using the Kirchhoff's laws we obtain the following equations

$$(7) \quad \begin{aligned} e_1 &= (R_1 + R_2)i_1 - R_2i_2 + L_1 \frac{di_1}{dt}, \\ e_2 &= -R_2i_1 + R_2i_2 + L_2 \frac{di_2}{dt}. \end{aligned}$$

The equations (7) can be written in the form

$$(8a) \quad \frac{d}{dt} \begin{bmatrix} i_1 \\ i_2 \end{bmatrix} = A \begin{bmatrix} i_1 \\ i_2 \end{bmatrix} + B \begin{bmatrix} e_1 \\ e_2 \end{bmatrix}$$

where

$$(8b) \quad A = \begin{bmatrix} -\frac{R_1 + R_2}{L_1} & \frac{R_2}{L_1} \\ \frac{R_2}{L_2} & -\frac{R_2}{L_2} \end{bmatrix}, \quad B = \begin{bmatrix} \frac{1}{L_1} & 0 \\ 0 & \frac{1}{L_2} \end{bmatrix}.$$

The electrical circuit is positive for all values of R_1, R_2 and nonzero L_1, L_2 since $A \in M_2$ and $B \in \mathfrak{R}_+^{2 \times 2}$.

Note that

$$(9) \quad \det A = \begin{vmatrix} -\frac{R_1 + R_2}{L_1} & \frac{R_2}{L_1} \\ \frac{R_2}{L_2} & -\frac{R_2}{L_2} \end{vmatrix} = \begin{vmatrix} -\frac{R_1}{L_1} & \frac{R_2}{L_1} \\ 0 & -\frac{R_2}{L_2} \end{vmatrix} = \frac{R_1 R_2}{L_1 L_2}.$$

From (8) it follows that

$$(10) \quad \det A = 0 \text{ if at least one of } R_1, R_2 \text{ is zero.}$$

Therefore, the electrical circuit shown on Fig. 1 is positive and unstable for $R_1 = 0$ and all values of R_2 and nonzero L_1, L_2 or for $R_2 = 0$ and all values of R_1, L_1, L_2 .

Note that the positive circuit is unstable if it has at least one mesh containing only inductances and source voltages.

Example 2. Consider the electrical circuit shown on Figure 2 with given resistances R_1, R_2, R_3 , inductances L_1, L_2, L_3 and source voltages e_1, e_2 .

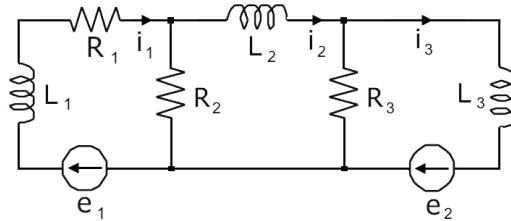

Fig. 2. Electrical circuit

Using the Kirchhoff's laws we obtain the following equations

$$(11) \quad \begin{aligned} e_1 &= (R_1 + R_2)i_1 - R_2i_2 + L_1 \frac{di_1}{dt}, \\ 0 &= -R_2i_1 + (R_2 + R_3)i_2 - R_3i_3 + L_2 \frac{di_2}{dt}, \\ e_2 &= -R_3i_2 + R_3i_3 + L_3 \frac{di_3}{dt}. \end{aligned}$$

The equations (11) can be written in the form

$$(12a) \quad \frac{d}{dt} \begin{bmatrix} i_1 \\ i_2 \\ i_3 \end{bmatrix} = A \begin{bmatrix} i_1 \\ i_2 \\ i_3 \end{bmatrix} + B \begin{bmatrix} e_1 \\ e_2 \end{bmatrix}$$

where

$$(12b) \quad A = \begin{bmatrix} -\frac{R_1 + R_2}{L_1} & \frac{R_2}{L_1} & 0 \\ \frac{R_2}{L_2} & -\frac{R_2 + R_3}{L_2} & \frac{R_3}{L_2} \\ 0 & \frac{R_3}{L_3} & -\frac{R_3}{L_3} \end{bmatrix}, \quad B = \begin{bmatrix} \frac{1}{L_1} & 0 \\ 0 & 0 \\ 0 & \frac{1}{L_3} \end{bmatrix}.$$

The electrical circuit is positive for all values of R_1, R_2, R_3 and nonzero L_1, L_2, L_3 since $A \in M_3$ and $B \in \mathfrak{R}_+^{3 \times 2}$.

Note that

$$(13) \quad \det A = \begin{vmatrix} -\frac{R_1 + R_2}{L_1} & \frac{R_2}{L_1} & 0 \\ \frac{R_2}{L_2} & -\frac{R_2 + R_3}{L_2} & \frac{R_3}{L_2} \\ 0 & \frac{R_3}{L_3} & -\frac{R_3}{L_3} \end{vmatrix} = \begin{vmatrix} -\frac{R_1}{L_1} & \frac{R_2}{L_1} & 0 \\ 0 & -\frac{R_2}{L_2} & \frac{R_3}{L_2} \\ 0 & 0 & -\frac{R_3}{L_3} \end{vmatrix} = -\frac{R_1 R_2 R_3}{L_1 L_2 L_3}.$$

From (13) it follows that

$$(14) \quad \det A = 0 \text{ if at least one of } R_1, R_2, R_3 \text{ is zero.}$$

Therefore, the electrical circuit shown on Fig. 2 is positive and unstable for $R_1 = 0$ and all values of R_2, R_3 and nonzero L_1, L_2, L_3 or for $R_2 = 0$ and all values of R_1, R_3, L_1, L_2, L_3 or $R_3 = 0$ and all values of R_1, R_2, L_1, L_2, L_3 .

Note that the positive circuit is unstable if it has at least one mesh containing only inductances and source voltages. It is easy to check that if two of the resistances R_1, R_2, R_3 are zero then the matrix A has a double zero eigenvalue ($s_1 = s_2 = 0$).

Example 3. Consider the electrical circuit shown on Figure 3 with given resistances R_1, R_2, R_3, R_4 , inductances L_1, L_2, L_3, L_4 and source voltages e_1, e_2, e_3 .

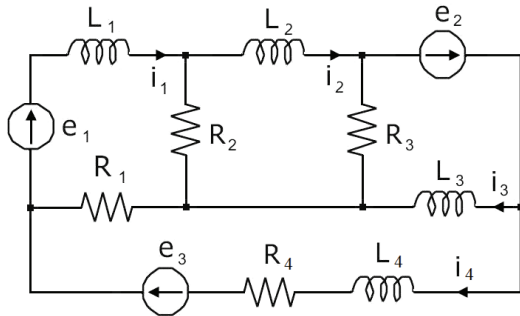

Fig. 3. Electrical circuit for example 3

Using the Kirchhoff's laws we obtain the following equations

$$\begin{aligned}
 e_1 &= (R_1 + R_2)i_1 - R_2i_2 - R_1i_4 + L_1 \frac{di_1}{dt}, \\
 0 &= -R_2i_1 + (R_2 + R_3)i_2 - R_3i_3 + L_2 \frac{di_2}{dt}, \\
 e_2 &= -R_3i_2 + R_3i_3 + L_3 \frac{di_3}{dt}, \\
 e_2 + e_3 &= -R_1i_1 - R_3i_2 + (R_1 + R_3 + R_4)i_4 + L_4 \frac{di_4}{dt}.
 \end{aligned}
 \tag{15}$$

The equations (15) can be written in the form

$$\frac{d}{dt} \begin{bmatrix} i_1 \\ i_2 \\ i_3 \\ i_4 \end{bmatrix} = A \begin{bmatrix} i_1 \\ i_2 \\ i_3 \\ i_4 \end{bmatrix} + B \begin{bmatrix} e_1 \\ e_2 \\ e_3 \end{bmatrix}
 \tag{16a}$$

where

$$A = \begin{bmatrix} -\frac{R_1 + R_2}{L_1} & \frac{R_2}{L_1} & 0 & \frac{R_1}{L_1} \\ \frac{R_2}{L_2} & -\frac{R_2 + R_3}{L_2} & \frac{R_3}{L_2} & 0 \\ 0 & \frac{R_3}{L_3} & -\frac{R_3}{L_3} & 0 \\ \frac{R_1}{L_4} & \frac{R_3}{L_4} & 0 & -\frac{R_1 + R_3 + R_4}{L_4} \end{bmatrix},
 \tag{16b}$$

$$B = \begin{bmatrix} \frac{1}{L_1} & 0 & 0 \\ 0 & 0 & 0 \\ 0 & \frac{1}{L_3} & 0 \\ 0 & \frac{1}{L_4} & \frac{1}{L_4} \end{bmatrix}.$$

The electrical circuit is positive for all values of R_1, R_2, R_3, R_4 and nonzero L_1, L_2, L_3, L_4 since $A \in M_4$ and $B \in \mathfrak{R}_+^{4 \times 3}$.

Note that

$$\det A = \begin{vmatrix} -\frac{R_1 + R_2}{L_1} & \frac{R_2}{L_1} & 0 & \frac{R_1}{L_1} \\ \frac{R_2}{L_2} & -\frac{R_2 + R_3}{L_2} & \frac{R_3}{L_2} & 0 \\ 0 & \frac{R_3}{L_3} & -\frac{R_3}{L_3} & 0 \\ \frac{R_1}{L_4} & \frac{R_3}{L_4} & 0 & -\frac{R_1 + R_3 + R_4}{L_4} \end{vmatrix}
 \tag{17}$$

$$= \begin{vmatrix} -\frac{R_1}{L_1} & \frac{R_2}{L_1} & 0 & 0 \\ 0 & -\frac{R_2}{L_2} & \frac{R_3}{L_2} & 0 \\ 0 & 0 & -\frac{R_3}{L_3} & 0 \\ \frac{R_1 + R_3}{L_4} & \frac{R_3}{L_4} & 0 & -\frac{R_4}{L_4} \end{vmatrix} = \frac{R_1 R_2 R_3 R_4}{L_1 L_2 L_3 L_4}.$$

From (17) it follows that

$$\det A = 0 \text{ if at least one of } R_1, R_2, R_3, R_4 \text{ is zero.}
 \tag{18}$$

Therefore, the electrical circuit shown on Fig. 3 is positive and unstable for one zero resistance and for all values of the remaining resistances and all values of nonzero inductances.

The positive circuit is unstable if it has at least one mesh containing only inductances and source voltages.

Thus, in general case we have the following theorem.

Theorem 3. The positive electrical circuit of R, L, e type is unstable if it has at least one mesh containing only coils and voltage sources.

Proof. To simplify the notation the proof will be accomplished for the positive circuit shown on Fig. 3 ($n = 4$). The stability is independent of the inputs and we may assume $e_k = 0, k = 1, 2, 3$. If $R_1 = 0$ then for the mesh containing inductances L_1, L_2, L_3 we have

$$L_1 \frac{di_1}{dt} + L_2 \frac{di_2}{dt} + L_3 \frac{di_3}{dt} = 0
 \tag{18}$$

and this implies linear dependence of rows (and columns) of the matrix A and $\det A = 0$. By Lemma 1 the positive electrical circuit is unstable. \square

Positive unstable G, C, i_s electrical circuits

In this section a class of G, C, i_s electrical circuits composed of resistors with conductances $G_i, i = 1, \dots, q_G$; condensators with capacitances $C_j, j = 1, \dots, q_C$ and source currents $i_{sk}, k = 1, \dots, m_i$ which are positive and unstable for all values of G_i, C_j will be proposed. These considerations are similar (dual) to the considerations in section 3.

Example 4. Consider the electrical circuit shown on Figure 4 with given conductances, G_1, G_2 , capacitances C_1, C_2 and source currents i_{s1}, i_{s2} .

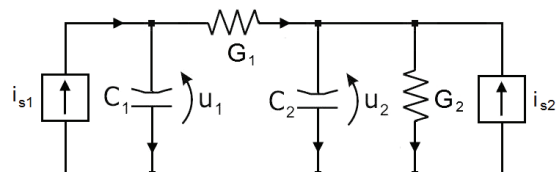

Fig. 4. Electrical circuit

Using the Kirchhoff's laws we obtain the following equations

$$(19) \quad \begin{aligned} i_{s1} &= G_1(u_1 - u_2) + C_1 \frac{du_1}{dt}, \\ i_{s2} &= -G_1 u_1 + (G_1 + G_2)u_2 + C_2 \frac{du_2}{dt}. \end{aligned}$$

The equations (19) can be written in the form

$$(20a) \quad \frac{d}{dt} \begin{bmatrix} u_1 \\ u_2 \end{bmatrix} = A \begin{bmatrix} u_1 \\ u_2 \end{bmatrix} + B \begin{bmatrix} i_{s1} \\ i_{s2} \end{bmatrix}$$

where

$$(20b) \quad A = \begin{bmatrix} -\frac{G_1}{C_1} & \frac{G_1}{C_1} \\ \frac{G_1}{C_2} & -\frac{G_1 + G_2}{C_2} \end{bmatrix}, \quad B = \begin{bmatrix} \frac{1}{C_1} & 0 \\ 0 & \frac{1}{C_2} \end{bmatrix}.$$

The electrical circuit is positive for all values of G_1, G_2 and nonzero C_1, C_2 since $A \in M_2$ and $B \in \mathfrak{R}_+^{2 \times 2}$.

Note that

$$(21) \quad \det A = \begin{vmatrix} -\frac{G_1}{C_1} & \frac{G_1}{C_1} \\ \frac{G_1}{C_2} & -\frac{G_1 + G_2}{C_2} \end{vmatrix} = \begin{vmatrix} -\frac{G_1}{C_1} & 0 \\ \frac{G_1}{C_1} & -\frac{G_2}{C_2} \end{vmatrix} = \frac{G_1 G_2}{C_1 C_2}.$$

From (21) it follows that

$$(22) \quad \det A = 0 \text{ if at least one of } G_1, G_2 \text{ is zero.}$$

Therefore, the electrical circuit shown on Fig. 4 is positive and unstable for $G_1 = 0$ and all values of G_2 and nonzero C_1, C_2 or for $G_2 = 0$ and all values of G_1, C_1, C_2 . If $G_2 = 0$ then positive unstable circuit has one node with branches containing only condensators and current sources.

Example 5. Consider the electrical circuit shown on Figure 5 with given resistances G_1, G_2, G_3 , capacitances C_1, C_2, C_3 and source currents i_{s1}, i_{s2} .

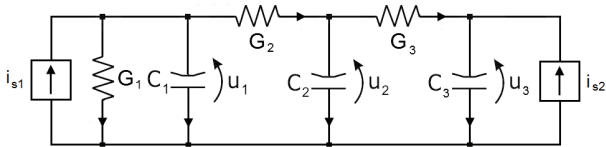

Fig. 5. Electrical circuit to example 5

Using the Kirchhoff's laws we obtain the following equations

$$(23) \quad \begin{aligned} i_{s1} &= (G_1 + G_2)u_1 - G_2 u_2 + C_1 \frac{du_1}{dt}, \\ 0 &= -G_2 u_1 + (G_2 + G_3)u_2 - G_3 u_3 + C_2 \frac{du_2}{dt}, \\ i_{s2} &= -G_3 u_2 + G_3 u_3 + C_3 \frac{du_3}{dt}. \end{aligned}$$

The equations (23) can be written in the form

$$(24a) \quad \frac{d}{dt} \begin{bmatrix} u_1 \\ u_2 \\ u_3 \end{bmatrix} = A \begin{bmatrix} u_1 \\ u_2 \\ u_3 \end{bmatrix} + B \begin{bmatrix} i_{s1} \\ i_{s2} \end{bmatrix}$$

where

$$(24b) \quad A = \begin{bmatrix} -\frac{G_1 + G_2}{C_1} & \frac{G_2}{C_1} & 0 \\ \frac{G_2}{C_2} & -\frac{G_2 + G_3}{C_2} & \frac{G_3}{C_2} \\ 0 & \frac{G_3}{C_3} & -\frac{G_3}{C_3} \end{bmatrix}, \quad B = \begin{bmatrix} \frac{1}{C_1} & 0 \\ 0 & 0 \\ 0 & \frac{1}{C_3} \end{bmatrix}.$$

The electrical circuit is positive for all values of G_1, G_2, G_3 and nonzero C_1, C_2, C_3 since $A \in M_3$ and $B \in \mathfrak{R}_+^{3 \times 2}$.

Note that

$$(25) \quad \begin{aligned} \det A &= \begin{vmatrix} -\frac{G_1 + G_2}{C_1} & \frac{G_2}{C_1} & 0 \\ \frac{G_2}{C_2} & -\frac{G_2 + G_3}{C_2} & \frac{G_3}{C_2} \\ 0 & \frac{G_3}{C_3} & -\frac{G_3}{C_3} \end{vmatrix} \\ &= \begin{vmatrix} -\frac{G_1}{C_1} & \frac{G_2}{C_1} & 0 \\ 0 & -\frac{G_2}{C_2} & \frac{G_3}{C_2} \\ 0 & 0 & -\frac{G_3}{C_3} \end{vmatrix} = -\frac{G_1 G_2 G_3}{C_1 C_2 C_3}. \end{aligned}$$

From (25) it follows that

$$(26) \quad \det A = 0 \text{ if at least one of } G_1, G_2, G_3 \text{ is zero.}$$

Therefore, the electrical circuit shown on Fig. 5 is positive and unstable for $G_1 = 0$ and all values of G_2, G_3 and nonzero C_1, C_2, C_3 or for $G_2 = 0$ and all values of G_1, G_3, C_1, C_2, C_3 or $G_3 = 0$ and all values of G_1, G_2, C_1, C_2, C_3 .

The positive circuit is unstable if $G_1 = 0$. In this case circuit has one node with branches containing only condensators and current sources. In general case we have the following theorem.

Theorem 4. The positive electrical circuit of G, C, i_s type is unstable if it has at least one node with branches containing only condensators and current sources.

Proof is similar to the proof of Theorem 3.

Positive unstable R, L, C, e type electrical circuits

In this section a class of R, L, C, e electrical circuits composed of resistors with resistances $R_i, i = 1, \dots, q_R$; coils with inductances $L_j, j = 1, \dots, q_L$; condensators with capacitances $C_k, k = 1, \dots, q_C$ and source voltages $e_l, l = 1, \dots, m_e$ which are positive and unstable for all values of parameters will be proposed.

Example 6. Consider the electrical circuit shown on Figure 6 with given resistance R_1 , Conductance G_1 inductance L , capacitance C and source voltage e .

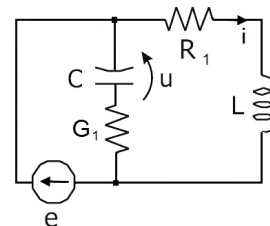

Fig. 6. Electrical circuit

Using the Kirchhoff's laws we obtain the following equations

$$(27) \quad \begin{aligned} e &= R_1 i + L \frac{di}{dt} \\ e &= u + \frac{C}{G_1} \frac{du}{dt} \end{aligned}$$

The equations (27) can be written in the form

$$(28a) \quad \frac{d}{dt} \begin{bmatrix} i \\ u \end{bmatrix} = A \begin{bmatrix} i \\ u \end{bmatrix} + Be$$

where

$$(28b) \quad A = \begin{bmatrix} -\frac{R_1}{L} & 0 \\ 0 & -\frac{G_1}{C} \end{bmatrix}, \quad B = \begin{bmatrix} \frac{1}{L} \\ \frac{G_1}{C} \end{bmatrix}.$$

The electrical circuit is positive for all values of R_1, G_1 and nonzero L, C since $A \in M_2$ and $B \in \mathfrak{R}_+^{2 \times 1}$.

From

$$(29) \quad \det A = \begin{vmatrix} -\frac{R_1}{L} & 0 \\ 0 & -\frac{G_1}{C} \end{vmatrix} = \frac{R_1 G_1}{LC}$$

it follows that

$$(30) \quad \det A = 0 \text{ if at least one of } R_1, G_1 \text{ is zero.}$$

Therefore, the electrical circuit shown on Fig. 6 is positive and unstable for $R_1 = 0$ and all values of G_1 and nonzero L, C or for $G_1 = 0$ and all values of R_1 and nonzero L, C .

Note that for $R_1 = 0$ the circuit has one mesh containing only the inductances and source voltages.

Example 7. Consider the electrical circuit shown on Figure 7 with given resistances R_1, R_2 , conductances G_1, G_2 , inductances L_1, L_2 , capacitances C_1, C_2 and source voltage e .

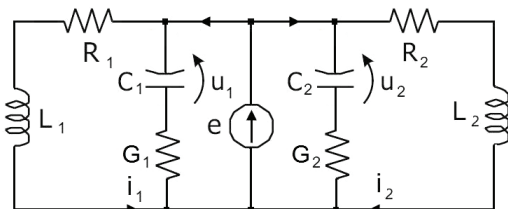

Fig. 7. Electrical circuit

Using the Kirchhoff's laws we obtain the following equations

$$(31) \quad \begin{aligned} e &= R_1 i_1 + L_1 \frac{di_1}{dt}, \\ e &= R_2 i_2 + L_2 \frac{di_2}{dt}, \\ e &= u_1 + \frac{C_1}{G_1} \frac{du_1}{dt}, \\ e &= u_2 + \frac{C_2}{G_2} \frac{du_2}{dt}. \end{aligned}$$

The equations (5.5) can be written in the form

$$(32a) \quad \frac{d}{dt} \begin{bmatrix} i_1 \\ i_2 \\ u_1 \\ u_2 \end{bmatrix} = A \begin{bmatrix} i_1 \\ i_2 \\ u_1 \\ u_2 \end{bmatrix} + Be$$

where

$$(32b) \quad A = \begin{bmatrix} -\frac{R_1}{L_1} & 0 & 0 & 0 \\ 0 & -\frac{R_2}{L_2} & 0 & 0 \\ 0 & 0 & -\frac{G_1}{C_1} & 0 \\ 0 & 0 & 0 & -\frac{G_2}{C_2} \end{bmatrix}, \quad B = \begin{bmatrix} \frac{1}{L_1} \\ \frac{1}{L_2} \\ \frac{G_1}{C_1} \\ \frac{G_2}{C_2} \end{bmatrix}.$$

The electrical circuit is positive for all values of R_1, R_2, G_1, G_2 and nonzero L_1, L_2, C_1, C_2 since $A \in M_4$ and $B \in \mathfrak{R}_+^{4 \times 1}$.

From

$$(33) \quad \det A = \begin{vmatrix} -\frac{R_1}{L_1} & 0 & 0 & 0 \\ 0 & -\frac{R_2}{L_2} & 0 & 0 \\ 0 & 0 & -\frac{G_1}{C_1} & 0 \\ 0 & 0 & 0 & -\frac{G_2}{C_2} \end{vmatrix} = \frac{R_1 R_2 G_1 G_2}{L_1 L_2 C_1 C_2}$$

it follows that

$$(34) \quad \det A = 0 \text{ if at least one of } R_1, R_2, G_1, G_2 \text{ is zero.}$$

Therefore, the electrical circuit shown on Fig. 7 is positive and unstable for at least one of resistances or one of the conductances is zero for all values of nonzero inductances and capacitances. If $R_1 = 0$ or $R_2 = 0$ then the positive unstable circuit has one mesh consisting of branches with only inductances and source voltages.

In general case consider the electrical circuit shown on Figure 8 with given resistances R_2, R_4, \dots, R_{n_2} , conductances G_1, G_3, \dots, G_{n_1} , inductances L_2, L_4, \dots, L_{n_2} , capacitances C_1, C_3, \dots, C_{n_1} and source voltages

e_0, e_2, \dots, e_{n_2} .

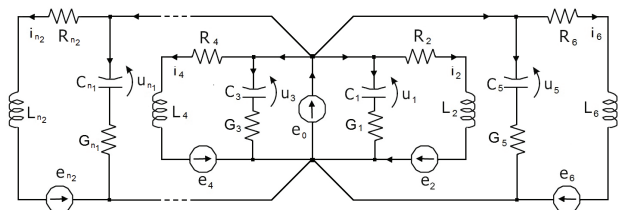

Fig. 8. Electrical circuit.

Using the Kirchhoff's laws we can write the equations

$$e_0 = u_k + \frac{C_k}{G_k} \frac{du_k}{dt},$$

$$(35) \quad e_j + e_0 = R_j i_j + L_j \frac{di_j}{dt},$$

$$k = 1, 3, \dots, n_1; \quad j = 2, 4, \dots, n_2$$

which can be written in the form

$$(36a) \quad \frac{d}{dt} \begin{bmatrix} u \\ i \end{bmatrix} = A \begin{bmatrix} u \\ i \end{bmatrix} + Be$$

where

$$i = \begin{bmatrix} i_2 \\ i_4 \\ \vdots \\ i_{n_2} \end{bmatrix}, \quad u = \begin{bmatrix} u_1 \\ u_3 \\ \vdots \\ u_{n_1} \end{bmatrix}, \quad e = \begin{bmatrix} e_0 \\ e_2 \\ \vdots \\ e_{n_2} \end{bmatrix}, \quad B = \begin{bmatrix} B_1 \\ B_2 \end{bmatrix},$$

$$(36b) \quad A = \text{diag} \left[-\frac{G_1}{C_1}, -\frac{G_3}{C_3}, \dots, -\frac{G_{n_1}}{C_{n_1}}, -\frac{R_2}{L_2}, -\frac{R_4}{L_4}, \dots, -\frac{R_{n_2}}{L_{n_2}} \right],$$

$$B_1 = \begin{bmatrix} \frac{G_1}{C_1} & 0 & \dots & 0 \\ \frac{G_3}{C_3} & 0 & \dots & 0 \\ \vdots & \vdots & \dots & \vdots \\ \frac{G_{n_1}}{C_{n_1}} & 0 & \dots & 0 \end{bmatrix}, \quad B_2 = \begin{bmatrix} \frac{1}{L_2} & \frac{1}{L_2} & 0 & \dots & 0 \\ \frac{1}{L_4} & 0 & \frac{1}{L_4} & \dots & 0 \\ \vdots & \vdots & \vdots & \dots & \vdots \\ \frac{1}{L_{n_2}} & 0 & 0 & \dots & \frac{1}{L_{n_2}} \end{bmatrix}.$$

From (36) it follows that the electrical circuit is positive for all values of the resistances and conductances and nonzero inductances and capacitances.

Note that

$$(37) \quad \det A = (-1)^{n_1+n_2} \frac{R_2 R_4 \dots R_{n_2} G_1 G_3 \dots G_{n_1}}{L_2 L_4 \dots L_{n_2} C_1 C_3 \dots C_{n_1}}$$

and the positive electrical circuit is unstable if at least one of G_1, G_3, \dots, G_{n_1} or one of R_2, R_4, \dots, R_{n_2} is zero for any nonzero values of C_1, C_3, \dots, C_{n_1} and L_2, L_4, \dots, L_{n_2} .

From the diagonal form of the matrix A it follows that the multiplicity of its zero eigenvalues is equal to the number of zero conductances and resistances.

If at least one of R_2, R_4, \dots, R_{n_2} is zero then the positive electrical circuit is unstable and it has at least one mesh consisting of branches with only inductances and source voltages.

Therefore, we have the following theorem.

Theorem 5. The positive electrical circuit of R, L, C, e type is unstable if it has at least one mesh containing only the inductances and source voltage.

A similar (dual) theorem can be formulated for positive electrical circuits having one node with branches consisting only of condensators and current sources (Theorem 4).

Concluding remarks

The instability for the positive linear electrical circuits composed of resistors, coils, condensators and voltage (current) sources has been addressed. Three different classes: R, L, e type, G, C, i_s type and R, L, C, e type of the

positive unstable linear electrical circuits have been proposed and analyzed. It has been shown that every positive electrical circuits of the three classes is unstable for all values of their parameters (Theorem 3, 4 and 5) if it has at least one mesh with branches containing only coils and voltage sources.

The considerations are illustrated by examples of electrical circuits belonging to three classes of positive and unstable circuits.

The considerations can be easily extended to positive fractional linear circuits [14].

Note that in this paper only sufficient conditions for instability of the positive linear electrical circuits have been established. An open problem is to establish the necessary and sufficient conditions for the instability of the positive electrical circuits.

Acknowledgment

This work was supported by National Science Centre in Poland under work S/WE/1/11.

REFERENCES

- [1] Farina L., Rinaldi S., *Positive Linear Systems; Theory and Applications*, J. Wiley, New York (2000).
- [2] Kaczorek T., *Positive 1D and 2D systems*, Springer Verlag, London (2001).
- [3] Kaczorek T., *Positivity and reachability of fractional electrical circuits*, Acta Mechanica et Automatica, Vol. 3 (2011), No. 1, 132-143.
- [4] Kaczorek T., *Positive electrical circuits and their reachability*, Proc. Conf. Computer Applications in Electrical Engineering, (2011) April 11-13, Poznan, Poland.
- [5] Kaczorek T., *Analysis of fractional electrical circuits in transient states*, (2010) LOGITRANS, Szczyrk, Poland.
- [6] Kaczorek T., *Singular fractional linear systems and electrical circuits*, Int. J. Appl. Math. Comput. Sci., Vol. 21 (2011), No. 2, 379-384.
- [7] Kaczorek T., *Asymptotic stability of positive continuous-time linear systems with mutual state-feedbacks*, Electrical Review, Vol. 87 (2011), No. 2, 163-166.
- [8] Kaczorek T., *Electrical circuits with state-feedbacks and desired dynamical properties*, Measurement Automation and Monitoring, Vol. 56 (2010), No. 5, 371-376.
- [9] Busłowicz M., *Robust stability of positive discrete-time linear systems of fractional order*, Bull. Pol. Acad. Sci. Techn., Vol. 58 (2010), No. 4, 567-572.
- [10] Kaczorek T., *Positive linear systems with different fractional orders*, Bull. Pol. Acad. Sci. Techn., Vol. 58 (2010), No. 3, 453-458.
- [11] Kaczorek T., *Positive linear systems consisting of n subsystems with different fractional orders*, IEEE Trans. Circ. and Syst., Vol. 58 (2011), No. 6, 1203-1210.
- [12] Antsaklis P.J., Michel A.N., *Linear Systems*, Birkhauser, Boston (2006).
- [13] Kaczorek T., *Linear Control Systems*, Vol. 1, J. Wiley, New York (1993).
- [14] Kaczorek T., *Selected Problems of Fractional Systems Theory*, Springer-Verlag, Berlin (2011).
- [15] Kailath T., *Linear Systems*, Prentice-Hall, Englewood Cliffs, New York (1980).
- [16] Rosenbrock H.H., *State-Space and Multivariable Theory*, J. Wiley, New York (1970).
- [17] Wolovich W.A., *Linear Multivariable Systems*, Springer-Verlag New York (1974).

Author: prof. dr hab. inż. Tadeusz Kaczorek, Białystok University of Technology, Faculty of Electrical Engineering, Wiejska 45D, 15-351 Białystok, Poland,
E-mail: kaczorek@isep.pw.edu.pl.