

Two-dimensional magnetic measurements – history and achievements of the workshop

This article is dedicated to Professor Dr. Karl-August Hempel, a great contributor and teacher in this field of metrology.

Abstract. An exemplary retrospect on two-dimensional metrology applied to electrical sheet steel is presented. First the history of this subject before the starting of this workshop series is considered, i.e. the time of the mechanical methods of d.c. rotational hysteresis and loss measurements and of inductive-mechanical methods of a.c. loss measurements. It is followed by the field-metric metrology of a.c. rotational magnetic phenomena. This method underwent a rapid increase of application due to the fast development of electronics for the excitation and data acquisition of magnetic field quantities in the 1970s and 1980s. Initiated by this development, the workshop series started shortly after in 1990. Besides the main item of the workshop, the metrology, the items modelling, theory and applications did enter the scope of the workshop soon. This retrospect focuses on the metrology of magnetic properties under two-dimensional excitation.

Streszczenie. Przedstawiono retrospekcję badań dwuwymiarowych w dziedzinie blach elektrotechnicznych z uwzględnieniem osiągnięć workshopów. Początki związane były z metodami mechaniki umożliwiającymi łatwą akwizycję wszystkich składowych pola magnetycznego i indukcji. Pomocą był tu rozwój elektroniki umożliwiający łatwą akwizycję wszystkich składowych. W związku z dynamicznym rozwojem tej dziedziny w latach dziewięćdziesiątych rozpoczęto organizację workshopów poświęconych tym zagadnieniom. Obok pomiarów zajmowano się też modelowaniem, teorią i zastosowaniem. (**Pomiary magnetyczne dwuwymiarowe – historia i osiągnięcia workshopów**)

Keywords: Electrical sheet steel, rotational power loss, metrology, historical survey

Słowa kluczowe: blachy elektrotechniczne, straty rotacyjne.

Introduction

Two-dimensional excitation of material is the generic term for circular rotating excitation in quasi-static (d.c.) or dynamic (a.c.) mode as well as a.c. dynamic elliptical or linear excitation in any direction of the solid ferromagnet. Thus, this phenomenon covers a very wide field of modes of the magnetization vector movement. This paper focuses on the a.c. circular rotation and consideration of the measurement of rotational loss and loci of flux density B and field strength H .

History of the mechanical measurement period

Surveys of this subject (see e.g. [1, 2,28]) usually start with referring to F.G. Baily's paper on "The hysteresis of iron and steel in rotating magnetic field" [3] where he describes the determination of the d.c. rotational loss by the torque-metric method. With this method, the torque exerted on a disc-shaped or spherical sample in a rotating magnetic field (alternatively the field is fixed and the sample rotated, see e.g. Zijlstra [4]) is measured over a full period of rotation of both directions. The difference of the two rotations delivers the double rotational hysteresis loss value. Another classical paper in this field was published by F. Brailsford who presented an advanced type of torque meter for this purpose [5] as shown in Fig.1.

A few more variations of mechanical methods which refer to the rotational loss measurement in a.c. fields have been practised and published, for instance the method of decay of the angular velocity of the sample rotating as a top in a constant magnetic field after switching off the driving force (Kelly [6]). Brix [7] has mounted the disc sample in a torque measuring suspension and rotated the external field vector over the sample using two vertically arranged pairs of Helmholtz coils. A supplementary method in an inductive-mechanical mode consists in rotating the sample in a constant magnetic field and measurement of the longitudinal and transverse components of the sample magnetization by means of an appropriate sensing coil system (Flanders [8]). Malkinski [9] used this method for simultaneous and correlated measurements of magnetic anisotropy and rotational Barkhausen noise of a SiFe single crystal disc. Fig.2 shows typical results of this

method. Nowadays the pure mechanical methods are almost out of date because of their tediousness and restricted information they yield, except there is a particular purpose as in the case of simultaneous anisotropy and Barkhausen noise measurement [9].

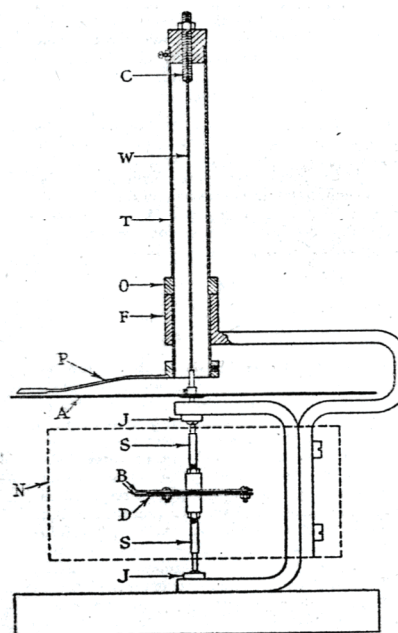

Fig.1: Torque magnetometer after Brailsford for the determination of rotational hysteresis loss [5]. C adjustment screw, W torsion wire, P pointer, A graduated aluminium disc, S spindles, D sample between brass discs (B) rotatable between the jewel bearings J (pointer for sample angular position not shown here).

Thermometric measurement methods

The thermometric determination of the rotational loss, mostly applied in the version of determining the rate of rise of the sample's temperature upon switching on the rotating magnetic field, played a particular and supplementing role. Depending on the knowledge of the heat capacitance of the

sample and the ability of realizing adiabatic conditions, it is an “absolute” method directly indicating the value of the energy dissipated in the fixed sample due to the rotating magnetic field. Several groups have used this cumbersome method mainly in the 1970ies. Fiorillo and Rietto have achieved excellent agreement between the thermometric and the fieldmetric method (see Fig.3).

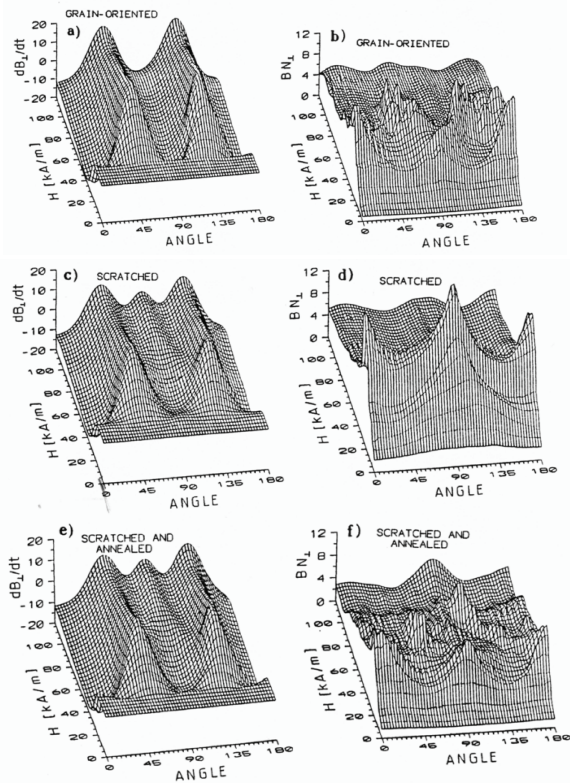

Fig.2: Anisotropy curves (a,c,e) and correlated Barkhausen noise curves (b,d,f), achieved from the signal after passing a high-pass filter (300 Hz to 100 kHz), picked up from the orthogonal sensing coils surrounding the 12 mm single crystal disc rotated by 5 Hz. Curves a,b: original, c,d: after applying scratches to the surface in $\langle 100 \rangle$ direction (vertical effect), e,f: after annealing at 850 °C, the macro-anisotropy remained unchanged, the Barkhausen noise regressed [9].

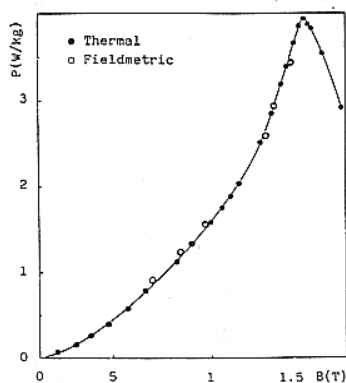

Fig.3: Rotational power loss vs. peak magnetic induction measured by thermal and fieldmetric method on a n.o. 3.2 % SiFe disc mounted in the same magnetic circuit arrangement [10])

The fieldmetric method and inception of the workshop

In 1975 Capptuller and Ahlers published the first application of the digital sampling method to magnetic loss measurements [11]. At that time the sample and hold electronics worked slowly so that they could achieve only one pair of B-H values in the time of 2 periods (plus

increment) of the 50 Hz wave. Thereafter, the rapid development of the speed of the digital sampling circuits brought about a revolution in this field of magnetic metrology. In an intermediate phase, B and H were picked up alternately using a switching chopper circuit thus needing only one measuring channel, though with negative impact on the measurement precision. However, a few years later fast simultaneous sampling of 4 measurement channels allowed the instantaneous acquisition of 4 correlated quantities, i.e. of H_x, H_y, B_x and B_y . The first application to electrical machinery was the determination of the loci of the rotating flux in a stator by Moses and Radley [43]. The rapid progress in electronics was the incentive for intensive activities on the field of two-dimensional magnetic metrology. The activities began preferably in Europe: Cardiff (Moses) Torino (Fiorillo), Aachen (Hempel), Braunschweig (Sievert), Grenoble (Brissonneaux and Kedous-Lebouc). In the early 1980, M.Enokizono introduced this metrology to Oita University and initiated spreading further activities in Japan. Consequently, the “First International Workshop on Magnetic Properties of Electrical Sheet Steel under Two-Dimensional Excitation” was held in 1991 in Braunschweig, followed by those in Oita (1992) and Torino (1993). Thereafter the enthusiasm declined slightly and the distances increased, until in 2000, H. Pfützner expanded the scope of the Workshop by inclusion of one-dimensional measurements and technical testing. Thereafter the Workshop was held regularly with two-years time intervals (see Table 1).

Table 1. Years, venues and Chairmen of the eleven workshops

1.	1991	Braunschweig	J.Sievert
2.	1992	Oita	M.Enokizono
3.	1993	Torino	F.Fiorillo
4.	1995	Cardiff	T.Meydan
5.	1997	Grenoble	A.Kedous-Lebouc
6.	2000	Bad Gastein	H.Pfützner
7.	2002	Luedenscheid	S.Siebert
8.	2004	Gent	L.Dupré
9.	2006	Czestochowa	M.Soinski
10.	2008	Cardiff	A.Moses
11.	2010	Oita	M.Enokizono

Fig. 4 shows the basic structure of a circuit for the two-dimensional measurement by the fieldmetric method using a square shaped sample. The data acquisition part is representative for almost all those circuits, whereas the feed-back control of the flux density is, in this case, analogue and includes the integration of the feed-back signal [12]. Alternatively digital feed-back techniques are applied allowing signal control up to higher flux densities.

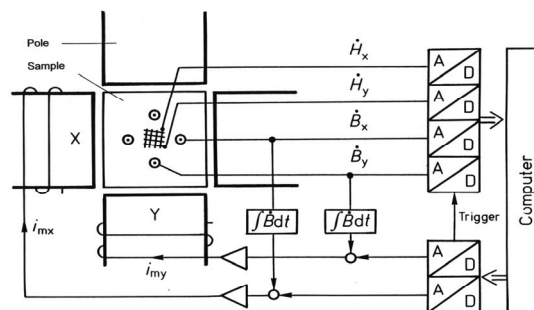

Fig.4: Block diagram of a set-up for the fieldmetric method of measurement of two-dimensional magnetic properties of electrical sheet steel based on the digital sampling procedure. The magnetic circuit (closure yokes and excitation coils on the right and on the upper pole were omitted) corresponds to the concept of the Aachen group (Prof. Hempel). For the sensors see text below.

The magnetic circuit shown in Fig. 4 follows the design developed by the Aachen group of K.A. Hempel [7,14,26].

As to the precision of modern electronic feedback and digital sampling methods, a round robin test among three European standard laboratories of one-dimensional power loss measurements using two highly stable ring cores of grain-oriented and non-oriented material were accomplished in 1999 [13]. The three labs applied exclusively the digital sampling method developed by themselves. The high precision of flux density setting and the B , H -signals acquisition is substantiated by an average deviation from the mean over all laboratories of 0.15 % for the n.o. and 0.08% for the g.o. ring sample. Thus, the achievable precision of loss measurements is limited exclusively by the material properties, the construction of the magnetic measurement circuit and by the characteristics of the field sensors used and not by the electrical components. This holds for one-dimensional, but even more for two-dimensional measurements.

Sensors for the fieldmetric method

With the fieldmetric method, the open magnetic circuit was replaced by the closed one through the use of closure yokes. Therefore, the self-demagnetization became irrelevant. However, it is in the nature of the two-dimensional metrological problem that the region of homogeneous flux distribution is relatively small, and so the sensors are necessarily small. Thus, their positioning and mutual angular adjustment have a strong influence on the measuring precision. Fig. 5 shows the schematic view of two sensor systems alternatively used for the detection of the flux density component B_y (for B_x the systems look correspondingly). The needles measure the eddy current voltage at the surface $E_x \cdot b = u(t)$ (b is the distance between the needles, d the thickness of the sheet) according to:

$$(1) \quad u(t) = -\frac{d \cdot b}{2} \dot{B}_y(t)$$

Salz [14] exemplified that the needles ignore the component E_z . On the other hand, the B-sensing coil, fed through the wholes drilled through the sheet, measures both, E_x and E_z . The power loss formed by the integrals of the Poynting vector $\mathbf{E} \times \mathbf{H}$, is given as:

$$(2) \quad P = -\frac{1}{T} \int_0^T \oint_{0(F)} (\mathbf{E} \times \mathbf{H}) dF dt = \\ = \frac{2}{T} \int_0^T \iint (H_x E_y - H_y E_x) dx dy dt$$

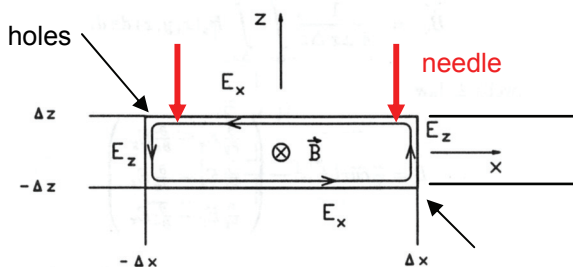

Fig.5: Cross sectional view of the sample in flux direction and alternative sensor systems for the magnetic flux density - needles (red) and coils wound through holes through the test specimen; for details see text below.

Eq. (2) implies that the energy enters the sample from the face-sides, i.e. the x - and y - field components only contribute to the loss. From these facts, it is concluded that the needles measure the power loss P correctly (E_z does not enter the loss integral of equ.(2)), but measure B with an error (neglecting E_z). In turn, the sensing coil measures B correctly but P with an error caused by the inclusion of E_z . A needle system is shown in Fig. 6a. The connections of the needles to the drilled part of the conductors must be such that inclusion of air flux is avoided. Detailed studies of the needle method have also been presented at the 7th Workshop by Oledzki and Pfützner et al. [32,33]. Again, the influence of the holes drilled through the sheet for the B-sensing coils, on the B-measurement precision was studied in the previous workshop by Tamaki et al.[36].

For the measurement of the magnetic field strength vector components, H_x and H_y , almost exclusively flat tangential field sensing coils, attached as close as possible to the sample's surface, are used. Sometimes also Rogowski-Chattock-potential-coils are used which are equivalent to the tangential coils as was shown by Xu [34]. The two tangential coils for sensing H_x and H_y were arranged one on each side of the sample [14]. Crossed x-y-coils both wound on the same former [51] shown in Fig.6b came more and more in use.

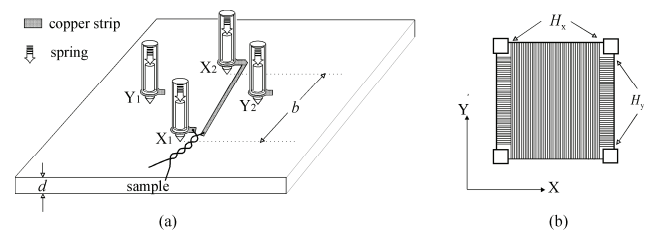

Fig.6: Needle sensors for B_x and B_y (a) and flat tangential cross coils for H_x and H_y (b). (drawing by J.Xu, Thesis, [16])

As we shall see below, the orthogonality of the x- and y-sensor axes and the parallelism of the H- and B- sensing systems are substantial for the measurement precision. Thus, the needle holder must be machined precisely. An angular misadjustment of the whole needle system (the needle pair axes being mutually orthogonal) causes considerable measurement errors as was shown by J. Xu [16]. Later this phenomenon was considered again in detail by Pfützner [40] and also by Maeda [41], Yanase et al. [42] and Todaka [47] (see below).

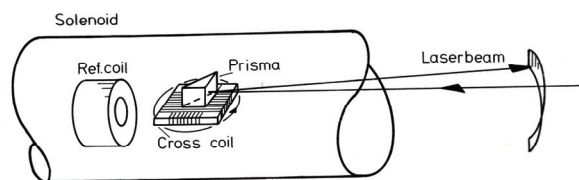

Fig.7: Arrangement for calibration of H cross coils (after Ahlers, Luedke and Sievert, see [15])

The H-sensing cross coils must be calibrated with regard to their winding areas and the orthogonality of their axes. For this purpose the system shown in Fig. 7 was introduced. For the orthogonality check, the turn table holding the cross coil under test is turned to a position, at which the signal induced by the homogeneous a.c. field of the solenoid in one of the two coils is zero, and after

repeating this procedure with the other coil, the angular positions of the two laser beam reflexes from the precise optical prism are compared. The axes of small H-cross coils can deviate from 90° , just statistically due to the winding process, by more than 1° and are then unusable.

The effect of angular misadjustment of one of the H-coils was studied [51,15,16]. For this the separate H_x -coil was arranged rotatable whilst all other sensors were held in fixed positions. Fig. 8 shows the effect of rotating the H_x -coil by small angles in both directions. The impact on the loss values measured on a n.o. sheet sample for clockwise (CLW) and counterclockwise (CCLW) rotation of the flux density vector is contrary. The horizontal line represents the results for the point by point average of the instantaneous B , H -data pairs (not the average of the filled and open circles of Fig. 8). Thus, it is substantiated, that the average, regardless how it was calculated, forms a realistic value free from this error. J.Xu has presented further cases and developed the mathematical background of this phenomenon [16]. More findings of this phenomenon in high fields are presented below.

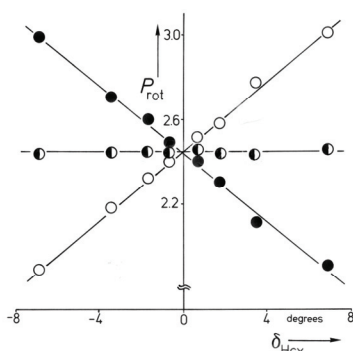

Fig.8: Rotational power loss measured on a n.o. sample under clockwise (open circles) and counterclockwise (full circles) flux vector rotation vs. direction angle of the axis of the H_x sensing coil. The semi-filled circles represent the curve for the point by point average of the instantaneous B, H -data pairs [15] (more in [16])

The determination of magnetic loss under rotating field

The Poynting vector integrated over the closed surface of the sample represents the flow of energy into the sample, and, when averaged over one period, the total magnetic loss P_t . From the left side of eq. (2) we obtain

$$(3) \quad P_t = \frac{1}{\rho T} \int \left(H \frac{dB}{dt} \right) = \frac{1}{\rho T} \int_0^T dB_x dt$$

This total loss has been split into an linear and rotational part [14]. The rotational part is then

$$(4) \quad P_r = \frac{2\pi}{\rho T} \int (\mathbf{H} \times \mathbf{B}) dt$$

Eq. (4) seems to be very concrete and was therefore often used at the early days of the fieldmetric method application [24]. However, it turned out that it is applicable only in the case of low anisotropy, with g.o. material Eq. (3) must be used [25,28] (see also below).

Rotating B and H vectors in electrical steel

Fig. 9a shows the traces of the B and H vectors rotating in the plane of a M400-65 n.o. sheet sample at flux densities of 1,0 T to 1.56 T. The outmost B and H loci are marked by symbols that are identical for the same instant of time. Of course, corresponding to the exciting current in the one-dimensional case, the exciting currents I_x and I_y are controlled so that B_x and B_y are sinusoidal and

consequently the B -loci are circular. In this case, asymmetries due to misadjustments of sensors (see Fig.8) are eliminated by point-by-point averaging of the measured CLW and CCLW loci. From the loci in Fig. 9a as well as from the phase angle difference φ between B and H vector in Fig. 9b it can be seen that H always leads B , i.e. the difference angle between H and B is always positive. In this case the simple formula for the loss, equ(4) can be applied.

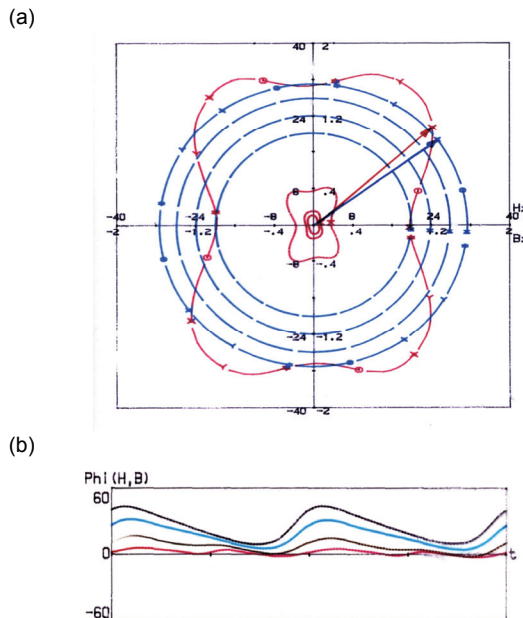

Fig 9 (a): Loci of B (blue) and H (red) field vectors rotating at 50 Hz in M400-65 non-oriented material (a), point by point average of CW and CCW rotation, flux densities between 1.0 and 1.56 T, the position of H and B vectors are indicated by corresponding markers on the curves.[15]; (b): Phase difference between B and H vector, φ , correlated to the curves shown in Fig.9(a)

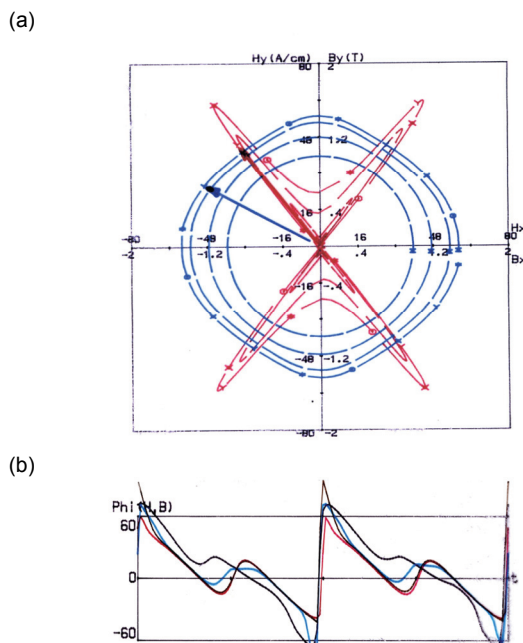

Fig 10: (a): Loci of B (blue) and H (red) field vectors rotating at 50 Hz in 0,30 mm grain-oriented material (a), point by point average of CW and CCW rotation, flux densities between 1.0 and 1.46 T, the position of H and B vectors are indicated by corresponding markers on the curves.[15]; (b): Phase angle difference between B and H vector, φ , correlated to the curves shown in Fig.10 (a)

Fig.10 shows the loci of the B and H vectors rotating in the plane of a grain-oriented sheet sample at flux densities of 1,0 T to 1.46 T. Again there are symbols assigned to the loci that are identical for the same instant of time. In higher flux densities, from 1.4 T upwards, the x-and y-excitation amplifiers cannot supply the enormous magnetizing current needed in the $\langle 111 \rangle$ -direction for keeping the B-components sinusoidal. Recently proper designs of the magnetic circuit and modern strong amplifiers enable sinusoidality (circularity) up to 1.9 T even with g.o. material (see below). The apparent strong anisotropy of this sample causes extremely irregular behaviour of the phase difference φ as can be seen from Fig. 10b. In low flux densities, φ can approach ± 90 degrees and H can jump by nearly 180 degrees. In the regions behind the $\langle 111 \rangle$ -direction peaks the B-vector leads the H-vector, i.e. the energy flows back from the sample into the surrounding field. In the case of this discontinuous phase behaviour, in particular with elliptical excitation of B, equ.(4) yields wrong results and only equ.(3) is applicable.

The magnetic circuit - yokes and sample shapes

Whilst the significance of concept and position of field sensors was considered in one of the previous sections it shall become evident that the design of the yokes is not less important for the accuracy of the two-dimensional measurements. Various concepts listed in Table 2 have been proposed.

Table 2. Various concepts of flux closure yoke systems

(1)	Vertical u-shaped yokes and Maltese cross shaped samples, the yokes can be (1a) symmetric double u-yokes (pairs) [17,18], or (1b) single yokes (one for each axis) [19].
(2)	Vertical yokes with horizontal pole pieces carrying the magnetizing windings and square shaped samples [20,21]
(3)	Vertical u-shaped yokes set on a large overhanging sheet sample [22,23,30]
(4)	Epstein strips with side-poles, tangential H- and B-sensing coils under 45 degrees [31]
(5)	Horizontal structures with square shaped samples and air gap for avoiding the straying of the flux over the pole of the other direction as shown in Fig.12 b) [7, 14,26,27,15]
(6)	Six-pole yokes and hexagon-shaped samples [29] as shown in Fig.12 f),
(7)	Stator-type designs with disc-shaped samples as shown in Fig.12 d) [37-39,45]
(8)	Arrangements which allow two-dimensional measurements under compressive or tensile stress [44].

A review of these arrangements with several drawings can also be found in [2]. The question of what is better, to separate the closure x and y flux from each other (concepts (1) to (4)), or allow common closure flux paths (concepts (5) to (7)) has not been finally decided.

The construction (3) of vertical yokes in combination with large over-hanging sheet samples (having dimensions 50cm x 50cm corresponding to the IEC standard 60404-3) was applied to study the possibility of using the magnetizing current instead of H-coils for the magnetic field strength measurement [22]. The error as related to H-coil measurements was fairly large, namely up to 27 % for the cut C-core yokes having the unfavourable lamination direction (see also Fig.12), and 17% for the stacked lamination, at 1.0 Tesla. The reason is that the y-poles form a parallel path for the x-flux and vice versa (particularly in the case of the cut C-core). However, the flux separation,

which is impossible with the 2-dimensional situation, is a precondition for the applicability of Ampere's law.

The influence of the sample and pole shapes with horizontal yoke constructions have been studied by J.Xu [16] and O.Bottauscio [35] using FEM calculation. Bottauscio's results in Fig. 11 show that the concepts b), d) and f) are favourable. The flux tends to keep the path through the highly reluctant air gap as short as possible, i.e. to pass it vertically. Obviously those concepts that avoid bending of the flux lines near the entering region show the highest field homogeneity in the centre of the samples. J.Xu came to the same conclusion with regard to the concepts b) and c) [16].

The early concepts (1) and (3) of Table 2 showed certain draw-backs, i.e. the expensive vertical yoke design and the right-angular bending of the flux where it penetrates the sample. Concept (4) was to use Epstein strips but introduced a inequality of x- and y-closure paths. Concept (2) has a straight flux penetration, but again the expensive vertical yoke construction.

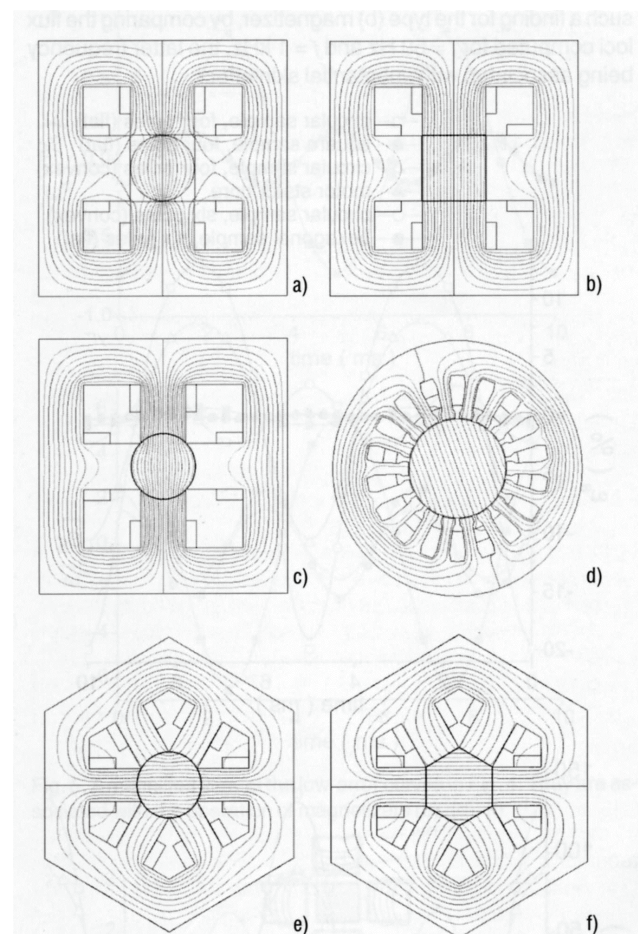

Fig 11: Different types of horizontal yokes and sample shapes on the field homogeneity in the centre region of the sample.; FEM calculation [35].

The horizontal concepts (5) to (7) (see also Fig.12) avoid the said drawbacks and were widely-used (at least concept (5) and Fig. 11 b). Concept (6), Fig.11 f), is a speciality of the Pfützner group in Vienna. It is expensive and brings along a particular difficult control of the flux wave because the non-orthogonal axes' signals are interdependent. However, once they solved that problem the closeness of one pole to the $\langle 111 \rangle$ -directions is a specific advantage for the flux control [29].

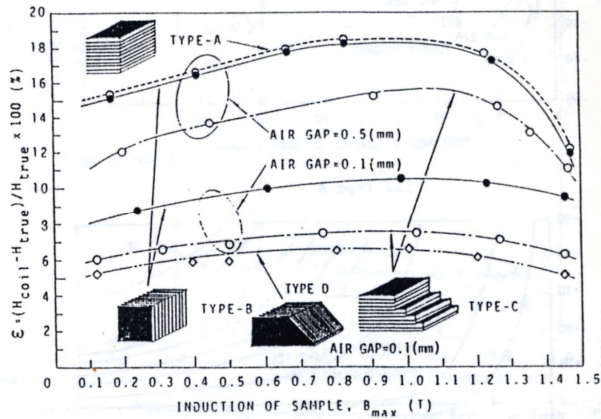

Fig. 12: Different types of yoke laminations and pole forms they influence the error of the field measurement in the center of the sample. The wedge shaped pole together with the type D lamination is most advantageous; FEM calculation by Enokizono [27].

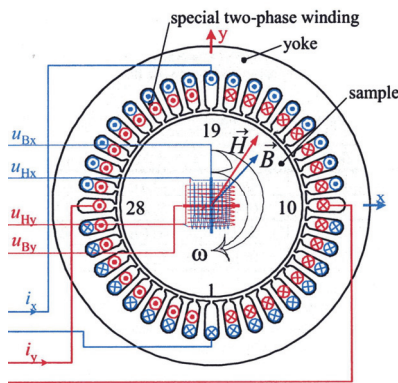

Fig. 13. Stator-type magnetic circuit for two-dimensional magnetic measurements on electrical sheet steel after Gorican et al. employing B-sensing coils and cross wound H-coils [38]

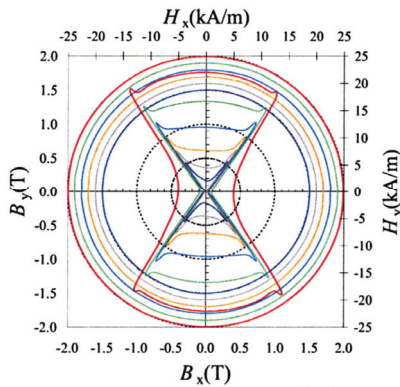

Fig. 14. B- and H-loci of clockwise circular rotation up to 2.0 T [38].

The direction of lamination of the yokes has an impact on the homogeneity of the flux in the centre of the sample where the field values are picked up. It is advantageous if the lamination of the x-pole is vertical to the direction of the y-flux, and that of the y-pole vertical to the x-flux. This was shown by Enokizono for horizontal yoke types applying FEM calculation (see. Fig. 12). It holds also for vertical yoke constructions which has been shown experimentally by means of the deviations of the field loci from circularity in the centre region of the sample [22]. A similar effect can be achieved by slitting the yokes as found by Yanase et al. by FEM calculations [42].

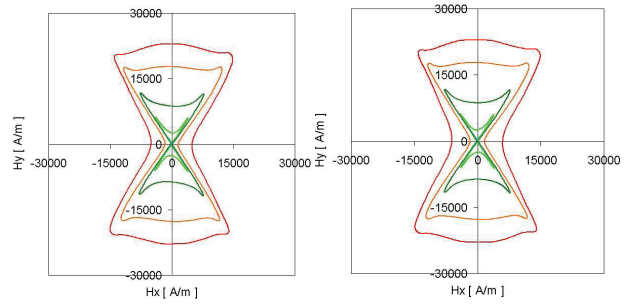

Fig. 15. H-Loci of circular B-rotation, $B = 1.5 \text{ T}$ to 1.9 T , in a c.g.o. sample at 50 Hz, clockwise (left) and counterclockwise (right), [49]

A stator-type magnetic circuit for the two-dimensional magnetic measurements on electrical sheet steel (Table 2, concept (7) and Fig.11d)) was used first by Fiorillo and Rietto. They employed a large air gap making a partial intrinsic magnetic field strength control. Later Gorican et al. [37,38], and Zurek [45,49] have again introduced such stator-like systems as shown in Fig. 13 with small air gaps and a rigid B-control. Okazaki et al. [39] used a vertical system without air gap, but again with windings distributed as two-pole system over the circle. Another concept of Yanase et al. used a square shaped vertical yoke system with exciting coils applied to the sample directly [42]. The stator-type systems [38, 45] are capable of reaching very high flux densities of 1.9 T and even 2.0 T as shown by Fig. 14 [38] and 15 [49]. In these cases we can see an almost perfect symmetry of the H loci with respect to the B_y axis. It is not clear why this almost perfect symmetry of the H loci is only found with the stator-type systems (see also Fig. 16). Another open question is how large the partition of air flux is in the B-curves presented. If a significant flux partition is included in the B-control it would mean that the magnetic polarization is not sinusoidal. Air flux could also be the reason why, in high fields, H is proportional to B in the $\langle 110 \rangle$ -region between the two $\langle 111 \rangle$ -directions (see Figs. 14 and 15).

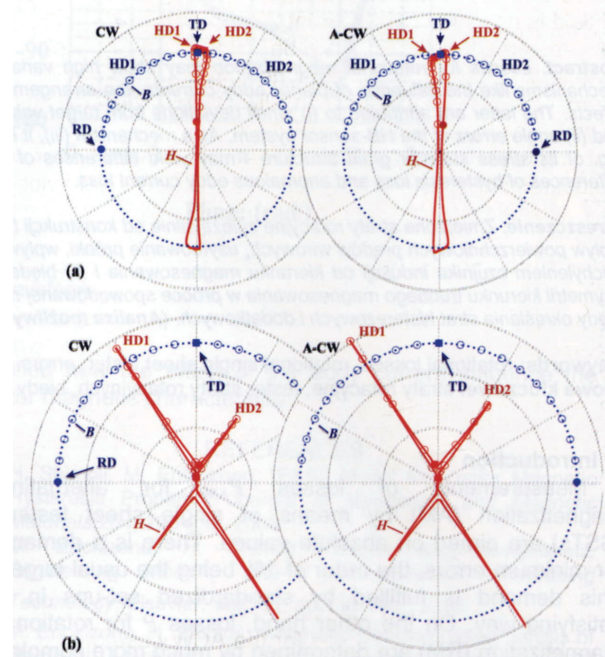

Fig. 16. B- and H-loci of clockwise (CW) and counterclockwise (ACW) circular rotation, h.g.o. material, measured at $B = 0.7 \text{ T}$ (a) and 1.3 T (b), after Prützner [40]

Recently two revised horizontal concepts using square shaped 80 mm x 80 mm samples were proposed. Sugimoto et al. [46] presented a 8-pole system, and Todaka et al. [47] and Maeda et al. [41] an Aachen-type 4-pole yoke system (see Figs.4 and 12(b)). Combined with a system of high power amplifiers, these concepts reached 1.9 T and even 2.0 T [41] with excellent circularity of B.

CLW/CCLW rotation and the sensing systems

Fundamental considerations on this item in the lower and medium field range have already been presented above (see Fig. 8). An extensive description, including the high field range, has been presented by Zurek in his PhD thesis, presenting and discussing a great variety of results [49]. In the very high flux density region, all these new systems (previous section) show large differences between the rotational loss values achieved for the CLW and CCLW rotation direction. Preferentially it is assumed that these differences have to be ascribed to misadjustments of the sensor systems. In fact, smallest deviations in the orthogonality of the x- and y- sensing system axes as well as lack of parallelism of the B- and H- system which both cannot be mastered by the manufacturing process, result in large CLW and the CCLW loss values differences. This has been found by several authors [15,16,38,41,42,45,47,49].

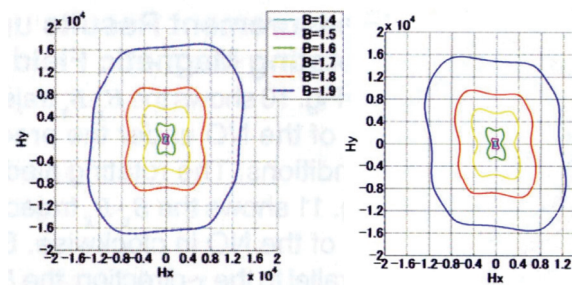

Fig.17. H-loci of clockwise (left) and counterclockwise (right) circular rotation, n.o. material, measured at B = 1.4T to 1.9 T after Sugimoto et al.; the B-locus is apparently circular [46]

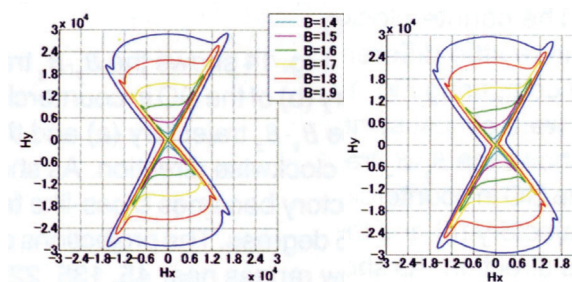

Fig.18. H-loci of clockwise (left) and counterclockwise (right) circular rotation, g.o. material, measured at B = 1.4 T to 1.9 T after Sugimoto et al.; the B-locus is apparently circular [46]

Experiments made by Pfützner et al. [40] seem to support the following interpretation: In low fields the H-loci of the CLW and CCLW rotation show an asymmetry with respect to the antirolling <110>-axis (TD in Figs.15) which is mirrored at the TD axis when changing the rotation direction (Fig. 16(a)). This may be expected due to the different pre-history of the domain structure when the B-vector rotates clockwise passing the RD-HD2-TD directions and anticlockwise passing through TD-HD1-RD, respectively. However, in higher flux densities there is no mirroring, in fact the two rotation directions show almost the same locus as shown in Fig. 16(b). This was interpreted as the predominant effect of the sensor axes misalignment.

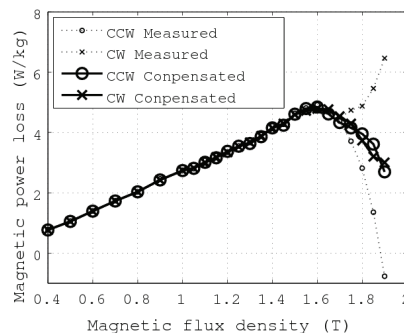

Fig.19. Rotational loss versus flux density, measured at CLW and CCLW rotation direction and compensated for the angle error between the Bx/By and the Hx/Hy sensing systems[41]

Other measurements made by Sugimoto et al. suggest that the largeness of the difference of the phase angles of B and H is decisive for the strength of the effect of the misalignments. The H- loci of the low-anisotropic n.o. material presented in Fig. 17 shows the behaviour which corresponds to that of Fig. 16(a) even at 1.9 T. On the other hand the H-loci of the anisotropic g.o. material shown in Fig. 18 tend to the behaviour shown in Fig. 16(b). This seems to be particularly accentuated in the middle B range, whilst, in the highest field range with smaller difference in the phase angles of B and H, the pattern becomes more symmetrical with respect to the TD direction (see Fig. 18).

Maeda et al. [41] found further evidence of the effects of the sensor axes misalignment, which in this case was assumed to be restricted to the angle error between the orthogonal B-sensor-system and the orthogonal H-sensor-system. The compensation of the misalignment angle was determined by establishing and solving an appropriate equation systems. Fig. 19 shows that the compensation leads to the almost same result when applied, using the same correction angle, to the CLW curve and to the CCLW curve, respectively. These results favour the proposed interpretation of the misalignment effects. At the same workshop, Yanase et al. [42] presented similar results including all three possible error angles (the 4th one can be set to zero as the reference). The result is similar to that shown in Fig. 19. It seems that in both cases the average of CLW and CCLW loss leads to the correct loss value, as it was already suggested earlier [15,16].

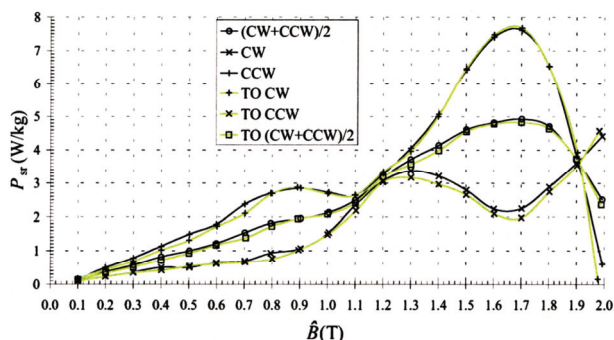

Fig.20. Rotational loss versus flux density, measured at CLW and CCLW rotation direction and average (middle curves) over the two rotation directions. compensated for the misalignment of the angle between Hx and Hy sensing coil axes [41].

This kind of curves has also been presented earlier by Gorican although without such an interpretation (see Fig. 20). The coincidence of the CLW curves with the turned-over CCLW curves after turning over the sample upside down (and vice versa) indicates that the symmetry of the

magnetic measurement circuit is apparently perfect, i.e. the misalignment is confined to the sensor system, and also the sample must be free of stress with an axis unsymmetrical with respect to the main anisotropy axes of the sample. Gorican's complicated curves are not yet explainable in all details. However, it is conceivable that the of CLW/CCLW difference decreases towards high fields due to smaller difference phase angles between B and H as suggested above. The crossing of the curves in high flux density which does exist neither in the curves of Maeda nor in those of Yanase, appears in the results of the stator-type systems of Gorican as well as of Zurek. The explanation based on small difference phase angles is not satisfying for this phenomenon.

Three-dimensional measurements on SM Components

Although this item seems to exceed the subject of this paper, Soft Magnetic Components (SMC) and their measurement were treated within the workshop. The increasing interest in coated iron powder arises from its formability and applicability to smallest magnetic circuit components. Zhu et al. [48,50] presented a set-up for this purpose. Fig. 21 shows the magnetic circuit design and the sensor system consisting of three surrounding B-measuring coils and six cross wound H-sensing coils, using a cubic sample.

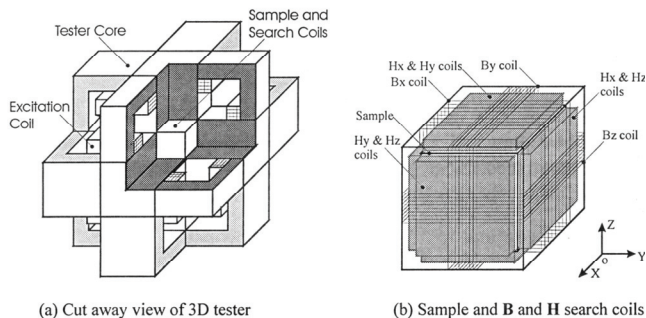

Fig.21. Magnetic circuit (a) and sensor system (b) for the three-dimensional measurements of soft magnetic iron powder samples (SMC), after Zhu et al. [48,50].

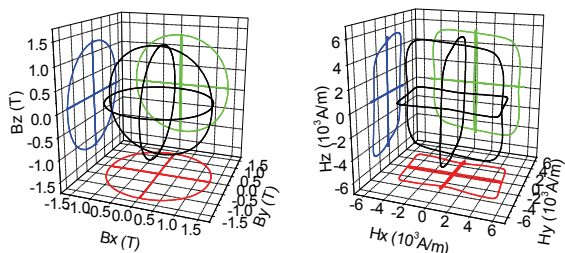

Fig. 22. Three dimensional magnetic measurements on a SMC powder sample, loci of B and H in the xy, xz and yz planes and their projections, circular rotation at 50 Hz, by means of the set-up shown in Fig.21 [48,50]

The B and H loci in the in the xy, xz and yz planes and their projections measured at 50 Hz using the set-up of Fig. 21 are shown in Fig.22. All the B loci are controlled to be circular. The y-direction turns out to be an easy direction.

Summary and conclusions

This workshop dealt with measurements, modelling, micromagnetic background and standardization of the two-dimensional magnetisation problem. For the reason of limited space, the paper had to be confined to the metrology aspects. Approximately, a chronological order was adhered to in order to outline the development of the subject.

Besides the pre-history the paper is focused to the fieldmetric measurement method with particular consideration of the error sources. It turns out that these phenomena still could form a wide field of further interesting experiments and studies. Further future perspectives were presented by A. Moses at this workshop.

Acknowledgement

The author expresses his thanks to his former staff and to the colleagues having generously supplied informations.

REFERENCES

- [1] Hempel, K. H.: Ferromagnetic materials in a rotating magnetic field: a centennial. 1st Int. Workshop on Magnetic Properties of Electrical Sheet Steel under Two-Dimensional Excitation. Proceedings of the 93th PTB-Seminar (ed.J.Sievert). PTB-E43 Braunschweig, April 1992, page1 (ISBN 3-89429-170-2)
- [2] Guo, Y., Zhu, J. G., Zhong, J., Lu, H., J. X. Jin: Measurement and Modeling of Rotational Core Losses of Soft Magnetic Materials Used in Electrical Machines: A Review. IEEE Trans. MAG **44**, No.2, Febr. 2008, 279-291.
- [3] Baily, F. G.; Philos. Trans. R. Soc.,vol. 187(1896), pp 715-746
- [4] Zijlstra, H.: Experimental methods in magnetism. North Nolland Publ. Comp., 1967
- [5] Braisford, F.: "Rotational hysteresis loss in electrical sheet steels. J. Inst. Elect. Eng. Vol **83**(1938) 566-575
- [6] Kelly J.M., 1957, New technique for measuring rotational hysteresis in ferromagnetic materials, Rev. Sc. Instr., **28**, 1957, 1038-1040
- [7] Brix W., Thesis,RWTH Aachen 1961
- [8] Flanders, P.J., Utilization of rotating sample magnetometer, Rev. Scientific Instrum. 41(1979) 697
- [9] Malkinski, L., J. Sievert, H. Ahlers, Proceedings of the 3rd Int. Workshop on the Magnetic Properties of Electrical Steel Sheets under Two-Dimensional Excitation, (eds.F.Foiarillo, C.Beatrice), Associazione Italiana di Metallurgia,Torino 1993, p. 43-54 (ISBN: 88-85298-18-4)
- [10] Fiorillo F. A.M. Rietto: The measurement of rotational losses at IEN – use of the thermometric method. Proceedings of the 1st .Int. Workshop on Magnetic Properties of Electrical Sheet Steel under Two-Dimensional Excitation, Braunschweig 1991 (ed. J. Sievert), PTB-Report-PTB-E-43, 162-172 .
- [11] Capptuller, H. H. Ahlers, Proc. Coll: Int. sur Electronique et la Mesure, Paris (1975) 607
- [12] Rahf, L.: Amplifier and control loop problems arising with the two-dimensional excitation: Proceedings of the 1st .Int. Workshop on Magnetic Properties of Electrical Sheet Steel under Two-Dimensional Excitation, Braunschweig 1991 (ed. J. Sievert), PTB-Report-PTB-E-43, 127-131 .
- [13] Sievert, J., H. Ahlers, F. Fiorillo, M. Hall , L. Henderson, L. Rocchino: Magnetic measurements on electrical steels using Epstein and SST methods - Euromet comparison between standard laboratories. Proceedings of the 6th Int.Workshop on 1&2-dimensional measurement and testing,Bad Gastein Sept. 2000, ed. H. Pfützner, Vienna, Magnetic Groups Reports, ISBN 3-902105-00-3, Vienna 2002, 194-203
- [14] Salz, W. K.A.Hempel: Which field sensors are suitable for rotating flux apparatus? 1st Int. Workshop on Magnetic Properties of Electrical Sheet Steel under Two- Dimensional Excitation, Braunschweig 1991 (ed. J. Sievert), PTB-Report-PTB-E-43, 117-126.
- [15] Sievert, J.: Studies of measurement of two-dimensional magnetic phenomena in electrical sheet steel at PTB. 1st Int. Workshop on Magnetic Properties of Electrical Sheet Steel under Two-Dimensional Excitation. Proceedings of the 93th PTB-Seminar (ed.J.Sievert). PTB-E43 Braunschweig, April 1992, page 102 (ISBN 3-89429-170-2)
- [16] Xu, J.: Untersuchung der Fehlerquellen bei der feldmetrischen Messung magnetischer Eigenschaften von Elektroblech bei zweidimensionaler Erregung. Thesis, PTB-E-56 Braunschweg Nov. 1997 (ISBN 3-89701-063-1)
- [17] Moses A.J., Thomas B., The spatial variation of localized power loss in two practical transformer T-joints, IEEE Trans. Magn., **9**, 1973, 655-659
- [18] Basak A. and A.J.Moses, Influence of stress on rotational loss in silicon iron, Proc. IEE **125**(2), (1978), 165-168.

- [19] Gumaidh, A.M., W.L.Mahadi, Y.Alinejad-Beromi, A.J.Moses, T.Meadan: Measurement and analysis of rotational power loss in soft magnetic materials. 1st Int. Workshop on Magnetic Properties of Electrical Sheet Steel under Two-Dimensional Excitation. Proceedings of the 93th PTB-Seminar (ed.J.Sievert). PTB-E43 Braunschweig, April 1992, page 173 - 190 (ISBN 3-89429-170-2)
- [20] Nakata, T., N.Takahashi, M.Nakano: Improvements of measuring equipments for rotational power loss. 1st Int. Workshop on Magnetic Properties of Electrical Sheet Steel under Two-Dimensional Excitation. Proceedings of the 93th PTB-Seminar (ed.J.Sievert). PTB-E43 Braunschweig, April 1992, page 191-199 (ISBN 3-89429-170-2)
- [21] Zouzou, S., A.Kedous-Lbouc, P. Brissonneau: Magnetic properties under unidirectional and rotational field. *J.Magn.Magn.Mater.* **112** (1992)106-108
- [22] Sievert, J., H.Ahlers, M.Enokizono, S.Kauke, L.Rahf, J.Xu: The measurement of rotational power loss in electrical sheet steel using a vertical yoke system. *J.Magn.Magn.Mater.* **112** (1992) 91
- [23] Enokizono, M., T.Todaka, T.Sashikata, J.D.Sievert, H.Ahlers: Magnetic field analysis of rotational loss tester with vertical yoke. *J. Magn.Magn.Mater.* **112**(1992) 81-84
- [24] Enokizono, M., J.D.Sievert: Magnetic field and loss analysis in an apparatus for the determination of rotational loss. *Physica Scripta***39**(1989) 356-359
- [25] Enokizono, M., T.Suzuki and J.D.Sievert: Measurement of Iron Loss Using Rotational Magnetic Loss Measurement Apparatus. *J.Magn.Soc.Japan* **14** (1990) 455
- [26] Brix, W. K.A.Hempel, F.J.Schulte: Improved method for the investigation of rotational magnetization process in electrical steel sheet. *IEEE Trans Mag MAG-20*(1984)1708 -1710
- [27] Enokizono, M., J.D.Sievert, H.Ahlers: Optimum Yoke Construction for Rotational Power Loss Measurements Apparatus. SMM9 Conference, Madrid 1989, *Anales de Fisica Serie B*, vol. **86** (1990), 320-322
- [28] Sievert, J.: On measuring the magnetic properties of electrical sheet steel under rotational magnetization. *J.Magn.Magn.Mat.* **112**(1992) 50-57
- [29] Hasenzagl, H., H. Pfützner: A 3-phase excited test system for simultaneous studies of field vectors, losses, magnetostriction and domains for multi-directional magnetisation. Proc.of the 4th International workshop on 2-dimensional magnetic problems, Cardiff 1995 (ed.A.J.Moses, T.Meydan), paper no.7 (ISBN 1-858-7-001-5)
- [30] Nencib, N., A. Cedous-Lebouc, B. Cornut: 3D analysis of a rotational loss tester with vertical yokes. *J. Magn.Magn.Mater.* **133** (1993) 553-556
- [31] Sasaki T., M. Imamura, S. Tadaka, Y. Suzuki: Measurement of rotational power losses in silicon-iron sheets using Wattmeter method. *IEEE Trans.Mag MAG-21* (1985)1918-1929
- [32] Oledzki, J.S.: Validation of the needle method for magnetic measurements. Proc.of the 7th Int. Workshop on 1&2 dimensional magnetic measurement and testing (ed.J.Sievert), Luedenscheid 2003, page 203-208. (ISBN 3-89701-992-2)
- [33] Pfützner, H., G. Krismanic: Systematic errors of the needle method for induction measurements. Proc.of the 7th Int. Workshop on 1&2 dimensional magnetic measurement and testing (ed.J.Sievert), Luedenscheid 2003, page 209-212. (ISBN 3-89701-992-2)
- [34] Xu, J.: Recent experiments on rotational power loss measurement at PTB. Proc.of the 4th International workshop on 2-dimensional magnetic problems, Cardiff 1995 (ed.A.J.Moses, T.Meydan), paper no.9 (ISBN 1-858-7-001-5)
- [35] Bottauscio, O., M.Chiampi, F.Fiorillo, A.Manzini: Space and time distribution of magnetic field in 2D magnetizers. Proc.of the 8th Int. Workshop on 1&2 dimensional magnetic measurement and testing (ed. L. Dupré), Ghent 2004, *Przeglad Elektrotechniczny*, R. **81** Nr 5/2005, 8-12.
- [36] Tamaki, t., K.Fujisaki, T.Yamada: Hole effect on magnetic field uniformity in Single Sheet Tester. Proc.of the 10th Int. Workshop on 1&2 dimensional magnetic measurement and testing, (ed. S.Zurek) Cardiff 2008, *Przeglad Elektrotechniczny* R. **85** Nr1/2009, 71-73
- [37] Gorican, V., A.Hamler, B.Hribernik, M.Jesenik,, M.Trieb: 2D magnetic measurements of magnetic properties using a round RSST. Proc.of the 6th Int. Workshop on 1&2 dimensional magnetic measurement and testing (ed.H.Pfützner), Bad Gastein, Vienna Magnetics Group Reports (2001) page 66-75 (ISBN 3-902105-00-3)
- [38] Gorican, V. M.Jesenik, A.Hamler, B.Stumberger, M.Trieb: Performance of round rotational single sheet tester (RRSST) at higher flux densities in the case of go materials. Proc.of the 7th Int. Workshop on 1&2 dimensional magnetic measurement and testing (ed.J.Sievert), Lüdenscheid 2003, page 143-150. (ISBN 3-89701-992-2)
- [39] Ichijo, N., S.Yanase, Y.Okazaki: A new 2D magnetic measurement method with vertical yokes. Proc.of the 7th Int. Workshop on 1&2 dimensional magnetic measurement and testing (ed.J.Sievert), Lüdenscheid 2003, page 197-201. (ISBN 3-89701-992-2)
- [40] Pfützner, H., G.Krismanic, H.Yamaguchi, E.Leiss, W.-Ch.Chiang: A study on possible sources of errors of loss measurement under rotational magnetization. Proc.of the 9th Int. Workshop on 1&2 dimensional magnetic measurement and testing, (eds. M.Soinski, S.Tumanski) Czestochowa 2007, *Przeglad Elektrotechniczny* R. **85** Nr4/2007, 9-13
- [41] Maeda, Y., S.Sugimoto, H.Shimoji, T.Todaka, M.Enokizono, J.Sievert: Study of the counterclockwise/clockwise (CCW/CW) rotation problem with the measurement of 2-dimensional magnetic properties. Proc.of the 9th Int. Workshop on 1&2 dimensional magnetic measurement and testing, (eds. M.Soinski, S.Tumanski) Czestochowa 2007, *Przeglad Elektrotechniczny*, R. **85** Nr4/2007, 18-24
- [42] Yanase, S., Y. Matsuno, S. Hashi, Y. Okazaki: 2D magnetic rotational loss of electrical steel at high magnetic flux density, Proc.of the 9th Int. Workshop on 1&2 dimensional magnetic measurement and testing, (eds. M.Soinski, S.Tumanski) Czestochowa 2007, *Przeglad Elektrotechniczny* R. **85** Nr4/2007, 31-34
- [43] Moses, A.J. and G.S. Radley, *J.Magn.Magn.Mat.* **19** (1980) 60-62 Section
- [44] Wakabayashi, D., Y.Maeda, H.Shimoji, T.Todaka, M.Enokizono: Measurement of vector magnetostriction in alternating and rotating magnetic field. Proc.of the 10th Int. Workshop on 1&2 dimensional magnetic measurement and testing, (ed. S.Zurek) Cardiff 2008, *Przeglad Elektrotechniczny* R. **85** Nr1/2009, 34-38
- [45] Zurek, S: Static and dynamic rotational losses in non-iron electrical steel. Proc.of the 10th Int. Workshop on 1&2 dimensional magnetic measurement and testing, (ed. S.Zurek) Cardiff 2008, *Przeglad Elektrotechniczny* R. **85** Nr1/2009, 89-92
- [46] Sugimoto, S., S.Urata, A.Ikariga, H.Shimoji, T.Todaka, M.Enokizono: A new measurement device for two-dimensional magnetic property in high magnetic flux density ranges. Proc.of the 8th Int. Workshop on 1&2 dimensional magnetic measurement and testing (ed. L. Dupré), Ghent 2004, *Przeglad Elektrotechniczny* R. **81** Nr 5/2005, 27-30.
- [47] Todaka, T., Y.Maeda, M.Enokizono: Counterclockwise/clockwise (CCW/CW) rotational losses under high magnetic field. Proc.of the 10th Int. Workshop on 1&2 dimensional magnetic measurement and testing, (ed. S.Zurek) Cardiff 2008, *Przeglad Elektrotechniczny* R. **85** Nr1/2009, 20-24
- [48] Zhu, J.G., J.J.Zhong, Z.W.Lin, J.Sievert: 3D Magnetic property tester – design, construction, and calibration. Proc.of the 7th Int. Workshop on 1&2 dimensional magnetic measurement and testing (ed.J.Sievert), Lüdenscheid 2003, page 97-102. (ISBN 3-89701-992-2)
- [49] Zurek, S: Two-dimensional magnetisation problems in electrical steels. PhD thesis, Wolfson Centre for Magnetics Technology, Cardiff University, March 2005
- [50] Zhu, J.G., Z.W.Lin, Y.G.Guo, Y.Huang: 3D measurement and modelling of magnetic properties of soft magnetic composites. Proc.of the 10th Int. Workshop on 1&2 dimensional magnetic measurement and testing, (ed. S.Zurek) Cardiff 2008, *Przeglad Elektrotechniczny* R. **85** Nr 1/2009, 11-15
- [51] Sievert, J. J.Xu, L.Rahf, M.Enokizono and H.Ahlers: Studies on the Rotational Power Loss Measurement Problem. SMM9 Conference Madrid 1989, *Anales de Fisica Serie B*, vol. **86** (1990), 35-37

Author: Dr. Ing. Dipl.-Phys. Johannes Sievert, Billrothstr. 2, 38116 Braunschweig – Germany, email: Johannes.sievert@t-online.de